

**Agilent 83486A
Optical/Electrical Plug-In Module
User's Guide**

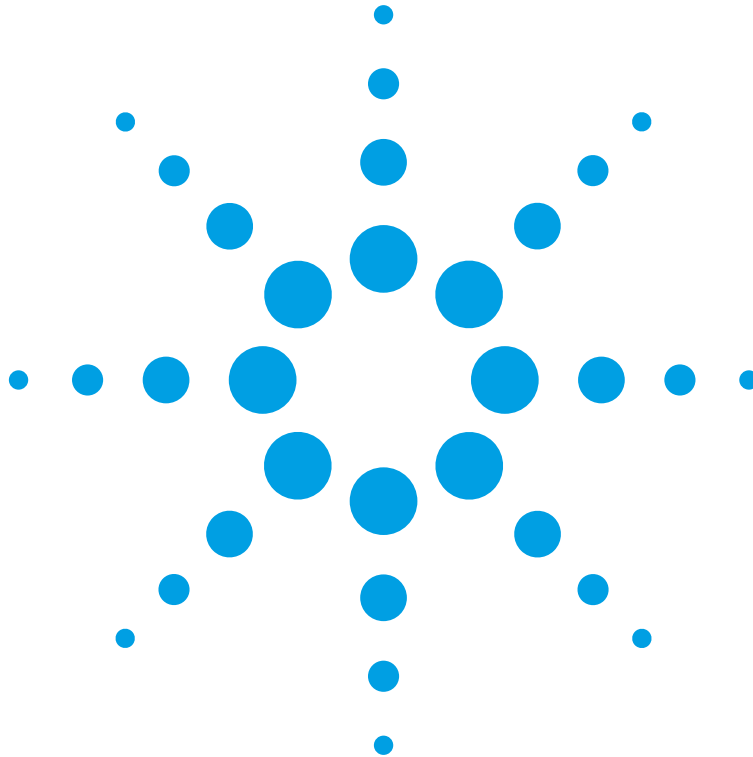

Agilent Technologies

© Copyright 2000
Agilent Technologies
All Rights Reserved. Reproduction, adaptation, or translation without prior written permission is prohibited, except as allowed under copyright laws.

Agilent Part No. 83486-90020
Printed in USA
March 2000

Agilent Technologies
Lightwave Division
1400 Fountaingrove Parkway
Santa Rosa, CA 95403-1799,
USA
(707) 577-1400

Notice.

The information contained in this document is subject to change without notice. Companies, names, and data used in examples herein are fictitious unless otherwise noted. Agilent Technologies makes no warranty of any kind with regard to this material, including but not limited to, the implied warranties of merchantability and fitness for a particular purpose. Agilent Technologies shall not be liable for errors contained herein or for incidental or consequential damages in connection with the furnishing, performance, or use of this material.

Restricted Rights Legend.

Use, duplication, or disclosure by the U.S. Government is subject to restrictions as set forth in subparagraph (c) (1) (ii) of the Rights in Technical Data and Computer Software clause at DFARS 252.227-7013 for DOD agencies, and subparagraphs (c) (1) and (c) (2) of the Commercial Computer Software Restricted Rights clause at FAR 52.227-19 for other agencies.

Warranty.

This Agilent Technologies instrument product is warranted against defects in

material and workmanship for a period of one year from date of shipment. During the warranty period, Agilent Technologies will, at its option, either repair or replace products which prove to be defective. For warranty service or repair, this product must be returned to a service facility designated by Agilent Technologies. Buyer shall prepay shipping charges to Agilent Technologies and Agilent Technologies shall pay shipping charges to return the product to Buyer. However, Buyer shall pay all shipping charges, duties, and taxes for products returned to Agilent Technologies from another country.

Agilent Technologies warrants that its software and firmware designated by Agilent Technologies for use with an instrument will execute its programming instructions when properly installed on that instrument. Agilent Technologies does not warrant that the operation of the instrument, or software, or firmware will be uninterrupted or error-free.

Limitation of Warranty.

The foregoing warranty shall not apply to defects resulting from improper or inadequate maintenance by Buyer, Buyer-supplied software or interfacing, unauthorized modification or misuse, operation outside of the environmental specifications for the product, or improper site preparation or maintenance.

No other warranty is expressed or implied. Agilent Technologies specifically disclaims the implied warranties of merchantability and fitness for a particular purpose.

Exclusive Remedies.

The remedies provided herein are buyer's sole and exclusive remedies. Agilent Technolo-

gies shall not be liable for any direct, indirect, special, incidental, or consequential damages, whether based on contract, tort, or any other legal theory.

Safety Symbols.

CAUTION

The *caution* sign denotes a hazard. It calls attention to a procedure which, if not correctly performed or adhered to, could result in damage to or destruction of the product. Do not proceed beyond a caution sign until the indicated conditions are fully understood and met.

WARNING

The *warning* sign denotes a hazard. It calls attention to a procedure which, if not correctly performed or adhered to, could result in injury or loss of life. Do not proceed beyond a warning sign until the indicated conditions are fully understood and met.



The instruction manual symbol. The product is marked with this warning symbol when it is necessary for the user to refer to the instructions in the manual.



The laser radiation symbol. This warning symbol is marked on products which have a laser output.



The AC symbol is used to indicate the required nature of the line module input power.



The ON symbols are used to mark the positions of the instrument power line switch.



The OFF symbols are used to mark the positions of the instrument power line switch.



The CE mark is a registered trademark of the European Community.



The CSA mark is a registered trademark of the Canadian Standards Association.



The C-Tick mark is a registered trademark of the Australian Spectrum Management Agency.

ISM1-A

This text denotes the instrument is an Industrial Scientific and Medical Group 1 Class A product.

Typographical Conventions.

The following conventions are used in this book:

Key type for keys or text located on the keyboard or instrument.

Softkey type for key names that are displayed on the instrument's screen.

Display type for words or characters displayed on the computer's screen or instrument's display.

User type for words or characters that you type or enter.

Emphasis type for words or characters that emphasize some point or that are used as place holders for text that you type.

The Agilent 83486A—At a Glance

The Agilent 83486A is one of several plug-in modules available for the Agilent 83480A, 54750A mainframes. The main features of the Agilent 83486A are:

- Integrated, calibrated optical channel.
- 2.5 GHz optical channel bandwidth and user selectable 12.4 or 20 GHz electrical channel bandwidth.
- 1000 nm to 1600 nm wavelength range.
- Optical channel has switchable 155/622 Mb/s SONET/SDH filters or 1063/1250 Mb/s datacom filters.
- 62.5/125 μm (maximum) multimode, user selectable optical input connector option.
- Electrical measurement channel.
- Trigger channel input to the mainframe.
- 3.5 mm (m) connectors on the electrical measurement channel and trigger channel.
- One probe power connector.
- One auxiliary power connector.

NOTE

If you wish to use the Agilent 83486A optical plug-in module in an Agilent 54750A digitizing oscilloscope, a firmware upgrade must first be installed. Order the Agilent 83480K communications firmware kit and follow the installation instructions.

The purpose of the plug-in module is to provide measurement channels, including sampling, for the mainframe. The plug-in module scales the input signal, sets the bandwidth of the system, and allows the offset to be adjusted so the signal can be viewed. The output of the plug-in module is an analog signal that is applied to the ADCs on the acquisition boards inside the mainframe. The plug-in module also provides a trigger signal input to the time base/trigger board inside the mainframe.

For GPIB programming information, refer to the *Agilent 83480A, 54750A Programmer's Guide* supplied with the mainframe.

Measurement Accuracy

To ensure that you obtain the specified accuracy, you must perform a plug-in module vertical calibration. The calibration must also be performed when you move a plug-in module from one slot to another, or from one mainframe to another. Refer to Chapter 3, “Calibration Overview” for information on performing a plug-in module vertical calibration.

CAUTION

The Agilent 83486A input circuitry can be damaged when the *total* input power levels exceed +10 dBm (10 mW) on the optical channel or ± 2 V + peak ac (+16 dBm) on the electrical channel. To prevent input damage, this specified level must not be exceeded.

Measurement accuracy—it's up to you!

Fiber-optic connectors are easily damaged when connected to dirty or damaged cables and accessories. The Agilent 83486A's front-panel INPUT connector is no exception. When you use improper cleaning and handling techniques, you risk expensive instrument repairs, damaged cables, and compromised measurements.

Before you connect any fiber-optic cable to the Agilent 83486A, refer to “Cleaning Connections for Accurate Measurements” on page 5-9.

General Safety Considerations

This product has been designed and tested in accordance with IEC Publication 61010-1, Safety Requirements for Electrical Equipment for Measurement, Control and Laboratory Use, and has been supplied in a safe condition. The instruction documentation contains information and warnings that must be followed by the user to ensure safe operation and to maintain the product in a safe condition.

WARNING

If this instrument is not used as specified, the protection provided by the equipment could be impaired. This instrument must be used in a normal condition (in which all means for protection are intact) only.

WARNING

To prevent electrical shock, disconnect the Agilent 83486A from mains before cleaning. Use a dry cloth or one slightly dampened with water to clean the external case parts. Do not attempt to clean internally.

WARNING

This is a Safety Class 1 product (provided with a protective earthing ground incorporated in the power cord). The mains plug shall only be inserted in a socket outlet provided with a protective earth contact. Any interruption of the protective conductor inside or outside of the product is likely to make the product dangerous. Intentional interruption is prohibited.

WARNING

No operator serviceable parts inside. Refer servicing to qualified personnel. To prevent electrical shock, do not remove covers.

WARNING

For continued protection against fire hazard, replace line fuse only with same type and ratings, (type T 0.315A/250V for 100/120V operation and 0.16A/250V for 220/240V operation). The use of other fuses or materials is prohibited. Verify that the value of the line-voltage fuse is correct.

- For 100/120V operation, use an IEC 127 5×20 mm, 0.315 A, 250 V, Agilent part number 2110-0449.
- For 220/240V operation, use an IEC 127 5×20 mm, 0.16 A, 250 V, Agilent Technologies part number 2110-0448.

General Safety Considerations

WARNING

There are many points in the instrument which can, if contacted, cause personal injury. Be extremely careful. Any adjustments or service procedures that require operation of the instrument with protective covers removed should be performed only by trained service personnel.

CAUTION

Before switching on this instrument, make sure that the line voltage selector switch is set to the line voltage of the power supply and the correct fuse is installed. Assure the supply voltage is in the specified range.

CAUTION

This product is designed for use in Installation Category II and Pollution Degree 2 per IEC 1010 and 664 respectively.

CAUTION

VENTILATION REQUIREMENTS: When installing the product in a cabinet, the convection into and out of the product must not be restricted. The ambient temperature (outside the cabinet) must be less than the maximum operating temperature of the product by 4°C for every 100 watts dissipated in the cabinet. If the total power dissipated in the cabinet is greater than 800 watts, then forced convection must be used.

CAUTION

Always use the three-prong ac power cord supplied with this instrument. Failure to ensure adequate earth grounding by not using this cord may cause instrument damage.

CAUTION

Do not connect ac power until you have verified the line voltage is correct. Damage to the equipment could result.

CAUTION

This instrument has autoranging line voltage input. Be sure the supply voltage is within the specified range.

CAUTION

Electrostatic discharge (ESD) on or near input connectors can damage circuits inside the instrument. Repair of damage due to misuse is *not* covered under warranty. Before connecting any cable to the electrical input, momentarily short the center and outer conductors of the cable together. Personnel should be properly grounded, and should touch the frame of the instrument before touching any connector.

Contents

The Agilent 83486A—At a Glance iii

1 Getting Started

The Agilent 83486A Optical/Electrical Plug-In Module 1-3

Options and Accessories 1-7

Menu and Key Conventions 1-8

Step 1. Inspect the Shipment 1-9

Step 2. Install the Plug-in Module 1-10

Returning the Instrument for Service 1-11

2 Channel Setup Menu

Channel Setup Menu 2-2

Displaying the Channel Setup Menus 2-5

3 Calibration Overview

Factory Calibrations 3-4

User Calibrations—Optical and Electrical 3-7

Complete Calibration Summary 3-19

4 Specifications and Regulatory Information

Specifications 4-3

Characteristics 4-7

Declaration of Conformity 4-8

5 Reference

In Case of Difficulty 5-2

Error Messages 5-5

Electrostatic Discharge Information 5-7

Cleaning Connections for Accurate Measurements 5-9

Agilent Technologies Service Offices 5-19

The Agilent 83486A Optical/Electrical Plug-In Module	1-3
Options and Accessories	1-7
Menu and Key Conventions	1-8
Step 1. Inspect the Shipment	1-9
Step 2. Install the Plug-in Module	1-10
Returning the Instrument for Service	1-11

Getting Started

Getting Started

This chapter gives a description of the plug-in module, lists options and accessories, explains menu and key conventions used, shows how to install your Agilent 83486A optical/electrical plug-in module, and gives information for returning the plug-in module for service.

Refer to Chapter 2, “Channel Setup Menu” for information on operating the plug-in module.

Refer to Chapter 3, “Calibration Overview” for calibration information.

Refer to Chapter 4, “Specifications and Regulatory Information” for information on operating conditions, such as temperature.

CAUTION

This product is designed for use in INSTALLATION CATEGORY II and POLLUTION DEGREE 2, per IEC 1010 and 664 respectively.

CAUTION

The input circuits can be damaged by electrostatic discharge (ESD). Therefore, avoid applying static discharges to the front-panel input connectors. Before connecting any coaxial cable to the connectors, momentarily short the center and outer conductors of the cable together. Avoid touching the front-panel input connectors without first touching the frame of the instrument. Be sure that the instrument is properly earth-grounded to prevent buildup of static charge. Refer to “Electrostatic Discharge Information” on page 5-7.

The Agilent 83486A Optical/Electrical Plug-In Module

The Agilent 83486A optical/electrical plug-in module incorporates two measurement channels, one optical and one electrical. The electrical channel has two selectable bandwidth settings. In the lower bandwidth mode of 12.4 GHz, oscilloscope noise performance is excellent, while the 20 GHz mode allows greater fidelity for high speed signals. The calibrated, integrated optical channel has over 2.85 GHz bandwidth and allows easy, precise measurements of single-mode or multimode optical signals.

The integrated optical channel reduces electrical mismatch loss variation by eliminating signal distorting cables and connectors associated with the use of external receivers in order to accurately characterize optical waveforms. The optical channel is calibrated to provide both accurate display of the received optical waveform in optical power units and measurement of the signal's average power. In addition, the User Cal feature provides for consistent accuracy at any wavelength between 1000 nm and 1600 nm using a source and power meter.

The Agilent 83486A optical/electrical plug-in module also is a calibrated SONET/SDH reference receiver that is measured to conform to ITU-TS G.957 and TANWT-000253 frequency response requirements (Option 040) or to reference receiver specifications for Fibre Channel (FC) 1063 and Gigabit Ethernet for transmitter compliance testing (Option 041). By pressing a front-panel key or issuing a GPIB command, a filter is inserted or removed from the measurement channel by a very repeatable Agilent Technologies microwave switch. The switch removes the potential variability and the time wasted by manually inserting and removing the filter when alternating between high-fidelity waveform characterization and SONET/SDH compliance testing.

The electrical measurement channel may be used to perform measurements on tributary electrical signals, to evaluate receiver performance in transceiver testing, for measurements with Agilent Technologies' wide range of external optical receivers, or for general purpose measurements.

The Agilent 83486A Optical/Electrical Plug-In Module

The Agilent 83486A optical/electrical plug-in module provides:

- 2.85 GHz, integrated, calibrated optical channel with sensitivity to below -20 dBm
- 12.4 GHz and 20 GHz electrical channel
- Trigger channel input to the mainframe
- Switchable reference filters for transceiver compliance testing
- Compliance testing at 155 and 622 Mb/s or FC 1063 and Gigabit Ethernet rates
- Measurement capability for single-mode or multimode optical signals

Front panel of the plug-in module

The plug-in module takes up two of the four mainframe slots. The optical channel provides calibrated measurement of optical waveforms in power units. The electrical channel provides calibrated measurement of electrical signals in volts. Bandwidths are selectable on both channels to optimize sensitivity and bandwidth. The front panel of the plug-in module has two channel inputs and an external trigger input. The front panel also has a Probe Power connector for Agilent 54700-series probes, an Aux Power connector for general purpose use, and a key for each channel that displays the softkey menu. The softkey menu allows you to access the channel setup features of the plug-in module.

The front-power Probe Power connector allows automatic channel scaling and probe calibration with Agilent 54700 series probes. The front-panel Aux Power connector provides only power to Agilent 54700 series probes for use as a trigger input. Probe calibration and scaling are not required for a trigger input.

The Agilent 83486A Optical/Electrical Plug-In Module

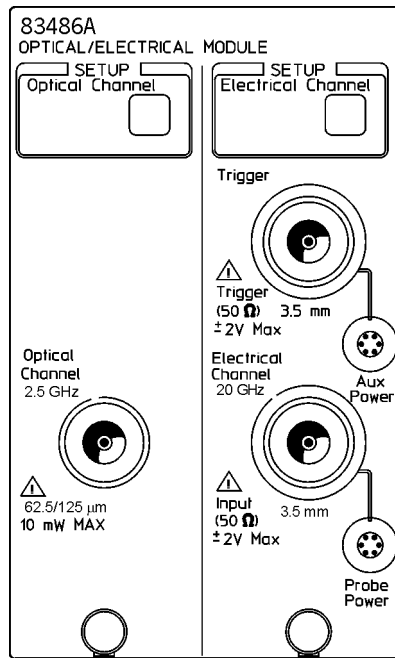

fm1pnl

Front panel of the plug-in module.

Trigger

The external trigger level range for this plug-in module is ± 1 V. The trigger source selection depends on the plug-in module location. For example, if the plug-in module is installed in slots 1 and 2, then the trigger source is listed as trigger 2. If it is installed in slots 3 and 4, then the trigger source is listed as trigger 4.

CAUTION

The maximum safe input voltage is ± 2 V + peak ac (+16 dBm).

CAUTION

The input circuits can be damaged by electrostatic discharge (ESD). Therefore, avoid applying static discharges to the front-panel input connectors. Before connecting any coaxial cable to the connectors, momentarily short the center and outer conductors of the cable together. Avoid touching the front-panel input connectors without first touching the frame of the instrument. Be sure that the instrument is properly earth-grounded to prevent buildup of static charge. Refer to “Electrostatic Discharge Information” on page 5-7.

Options and Accessories

Options

Option 0B1 Additional set of user documentation
Option 0B0 Deletes the user documentation
Option UK6 Measured performance data

Option 001 Latest version of operating firmware for the Agilent 83480A
Option 002 Latest version of operating firmware for the Agilent 54750A
Option 011 Diamond HMS-10 connector interface
Option 012 FC/PC connector adapter
Option 013 DIN connector adapter
Option 014 ST connector adapter
Option 015 Biconic connector adapter
Option 017 SC connector adapter
Option 040 155 and 622 Mb/s switchable internal filters
Option 041 1063 and 1250 Mb/s switchable internal filters

Optional accessories

Agilent 10086A ECL terminator
Agilent 11982A high-speed lightwave receiver
Agilent 54006A 6 GHz divider probe
Agilent 54008A 22 ns delay line
Agilent 54118A 500 MHz to 18 GHz trigger
Agilent 83430A lightwave digital source
Agilent 83440B/C/D high-speed lightwave receiver
Agilent 83446A/B lightwave clock and data receiver
Agilent 83447A lightwave trigger receiver

Connection devices

SMA (f-f) adapter, Agilent Technologies part number 1250-1158
APC 3.5 (f-f) adapter, Agilent Technologies part number 1250-1749
Agilent 81000FI FC/PC/SPC/APC connector interface
Agilent 81000KI SC connector interface
Agilent 81000SI DIN 47256/4108.6 connector interface
Agilent 81000VI ST connector interface
Agilent 81000WI Biconic

Menu and Key Conventions

The keys labeled Trigger, Disk, and Run are all examples of front-panel keys. Some front-panel keys bring up menus on the right side of the display screen. These menus are called softkey menus.

Softkey menus contain functions not available directly by pressing the front-panel keys. To activate a function on the softkey menu, press the unlabeled key immediately next to the annotation on the screen. The unlabeled keys next to the annotations on the display are called softkeys.

Additional functions are listed in blue type above and below some of the front-panel keys. These functions are called shifted functions. To activate a shifted function, press the blue front-panel Shift key and the front-panel key next to the desired function.

Throughout this manual front-panel keys are indicated as, for example, Timebase. Softkeys are indicated as, for example, *Mask Align*. The softkeys displayed depend on the front-panel key pressed and which menu is selected. Shifted functions are indicated by the front-panel Shift key followed by, for example, the Local function (above the Stop/Single front-panel key) and will be shown as Shift, Local.

A softkey with On and Off in its label can be used to turn the softkey's function on or off. To turn the function on, press the softkey so that *On* is highlighted. To turn the function off, press the softkey so that *Off* is highlighted. An On or Off softkey function will be indicated throughout this manual as, for example, *Test On*.

A softkey such as *Sweep Triggered Freerun* offers you a choice of functions. In this case, you could choose *Triggered* by pressing the softkey until *Triggered* is highlighted, or choose *Freerun* by pressing the softkey until *Freerun* is highlighted. A choices softkey will be indicated throughout this manual as, for example, *Sweep Triggered Freerun Triggered*.

When some softkeys, such as *Calibrate probe*, are pressed the first time, a measurement will be made and the result will be provided. Some softkeys, such as *Offset*, require the entry of a numeric value. To enter or change the value, use the general purpose knob located below the front-panel Measure section.

Step 1. Inspect the Shipment

- 1** Verify that all system components ordered have arrived by comparing the shipping forms to the original purchase order. Inspect all shipping containers. The shipment includes:
 - Agilent 83486A optical/electrical plug-in with the ordered options and adapters.
 - APC 3.5 (f-f) adapter, Agilent Technologies part number 5061-5311, 2 each
 - SMA 50 Ω termination, Agilent Technologies part number 1810-0118, 2 each

If your shipment is damaged or incomplete, save the packing materials and notify both the shipping carrier and the nearest Agilent Technologies service office. Agilent Technologies will arrange for repair or replacement of damaged or incomplete shipments without waiting for a settlement from the transportation company. Notify the Agilent Technologies customer engineer of any problems.

- 2** Make sure that the serial number and options listed on the instrument's rear-panel label match the serial number and options listed on the shipping document.

Step 2. Install the Plug-in Module

You do *not* need to turn off the mainframe to install or remove the plug-in modules.

Note

If you wish to use the Agilent 83486A optical plug-in module in an Agilent 54750A digitizing oscilloscope, a firmware upgrade must first be installed. Order the Agilent 83480K communications firmware kit and follow the installation instructions.

Note

The Agilent 83486A requires firmware revision A.06.0 or higher.

The plug-in module can be installed in slots 1 and 2 or 3 and 4 on the Agilent 83480A or Agilent 54750A mainframe. The plug-in module will *not* function if it is installed in slots 2 and 3.

To make sure the analyzer meets all of the published specifications, there must be a good ground connection from the plug-in module to the mainframe. The RF connectors on the rear of the plug-in module are spring-loaded, so finger-tighten the knurled screw on the front panel of the plug-in module to make sure the plug-in is securely seated in the mainframe.

CAUTION

Do not use non-Agilent Technologies extender cables to operate the plug-in module outside of the mainframe. The plug-in module can be damaged by improper grounding when using extender cables.

Returning the Instrument for Service

The instructions in this section show you how to properly return the instrument for repair or calibration. Always call the Agilent Technologies Instrument Support Center first to initiate service *before* returning your instrument to a service office. This ensures that the repair (or calibration) can be properly tracked and that your instrument will be returned to you as quickly as possible. Call this number regardless of where you are located. Refer to “Agilent Technologies Service Offices” on page 5-19 for a list of service offices.

Agilent Technologies Instrument Support Center. (800) 403-0801

If the instrument is still under warranty or is covered by an Agilent Technologies maintenance contract, it will be repaired under the terms of the warranty or contract (the warranty is at the front of this manual). If the instrument is no longer under warranty or is not covered by an Agilent Technologies maintenance plan, Agilent Technologies will notify you of the cost of the repair after examining the unit.

When an instrument is returned to a Agilent Technologies service office for servicing, it must be adequately packaged and have a complete description of the failure symptoms attached. When describing the failure, please be as specific as possible about the nature of the problem. Include copies of additional failure information (such as the instrument failure settings, data related to instrument failure, and error messages) along with the instrument being returned.

Preparing the instrument for shipping

- 1 Write a complete description of the failure and attach it to the instrument. Include any specific performance details related to the problem. The following

Returning the Instrument for Service

information should be returned with the instrument.

- Type of service required.
 - Date instrument was returned for repair.
 - Description of the problem:
 - Whether problem is constant or intermittent.
 - Whether instrument is temperature-sensitive.
 - Whether instrument is vibration-sensitive.
 - Instrument settings required to reproduce the problem.
 - Performance data.
 - Company name and return address.
 - Name and phone number of technical contact person.
 - Model number of returned instrument.
 - Full serial number of returned instrument.
 - List of any accessories returned with instrument.
- 2** Cover all front or rear-panel connectors that were originally covered when you first received the instrument.

CAUTION

Cover electrical connectors to protect sensitive components from electrostatic damage. Cover optical connectors to protect them from damage due to physical contact or dust.

CAUTION

Instrument damage can result from using packaging materials other than the original materials. Never use styrene pellets as packaging material. They do not adequately cushion the instrument or prevent it from shifting in the carton. They may also cause instrument damage by generating static electricity.

- 3** Pack the instrument in the original shipping containers. Original materials are available through any Agilent Technologies office. Or, use the following guidelines:
- Wrap the instrument in antistatic plastic to reduce the possibility of damage caused by electrostatic discharge.
 - For instruments weighing less than 54 kg (120 lb), use a double-walled, corrugated cardboard carton of 159 kg (350 lb) test strength.
 - The carton must be large enough to allow approximately 7 cm (3 inches) on all sides of the instrument for packing material, and strong enough to accommodate the weight of the instrument.
 - Surround the equipment with approximately 7 cm (3 inches) of packing material, to protect the instrument and prevent it from moving in the carton. If packing foam is not available, the best alternative is S.D-240 Air Cap™ from

Sealed Air Corporation (Commerce, California 90001). Air Cap looks like a plastic sheet filled with air bubbles. Use the pink (antistatic) Air Cap™ to reduce static electricity. Wrapping the instrument several times in this material will protect the instrument and prevent it from moving in the carton.

- 4** Seal the carton with strong nylon adhesive tape.
- 5** Mark the carton “FRAGILE, HANDLE WITH CARE”.
- 6** Retain copies of all shipping papers.

Channel Setup Menu 2-2

Displaying the Channel Setup Menus 2-5

Channel Setup Menu

Channel Setup Menu

This chapter describes the Channel Setup menu. A key tree and description of the available functions is included.

CAUTION

The input circuits can be damaged by electrostatic discharge (ESD). Therefore, avoid applying static discharges to the front-panel input connectors. Before connecting any coaxial cable to the connectors, momentarily short the center and outer conductors of the cable together. Avoid touching the front-panel input connectors without first touching the frame of the instrument. Be sure that the instrument is properly earth-grounded to prevent buildup of static charge. Refer to “Electrostatic Discharge Information” on page 5-7.

At the top of the plug-in module are the Channel keys. These keys give you access to the Channel Setup menu for each input. The Channel Setup menu is displayed on the right side of the screen when the Channel key is pressed. There are several types of softkeys available. A description of the different softkeys and their functions is provided in the *Agilent 83480A, 54750A User's Quick Start Guide* supplied with the mainframe.

NOTE

The plug-in module has both an electrical channel and an optical channel. Although many of the softkeys are similar, some differences exist. Examples in this book using the optical channel will note when the user would see differences if using the electrical channel.

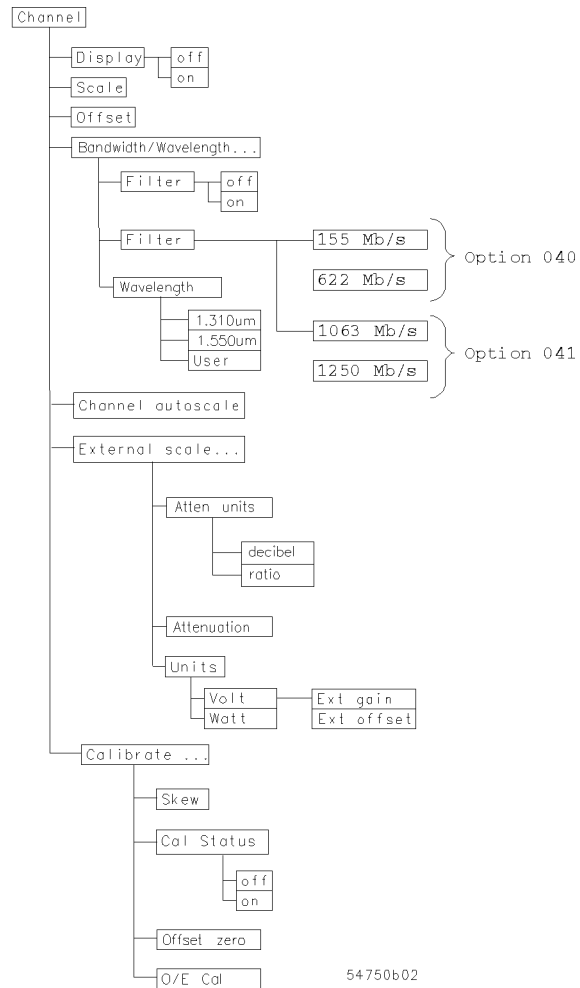
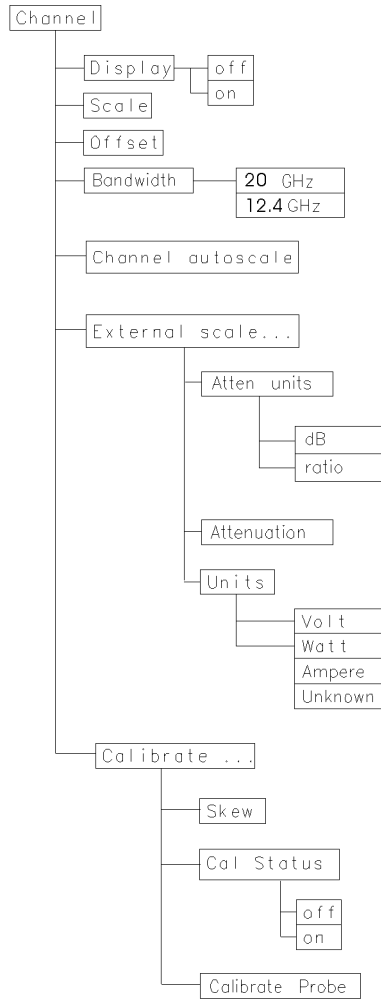

Figure 2-1. Optical Channel Setup menu.

Channel Setup Menu

Channel Setup Menu



chanmen

Figure 2-2. Electrical Channel Setup menu.

Displaying the Channel Setup Menus

To display the optical Channel Setup menu, press the Optical Channel key located above the optical input connector.

To display the electrical Channel Setup menu, press the Electrical Channel key located above the electrical input connector.

Display

The *Display* softkey turns the channel display off and on. When the channel display is on, a waveform is displayed for that channel, unless the offset is adjusted so the waveform is clipped off the display.

The channel number, vertical scaling, and offset are displayed at the bottom left of the waveform area. They remain on the display until the channel is turned off, or an automatic measurement is performed. The automatic measurement results share the same area of the display as the channel setups.

When the channel display is off, the waveform display for that channel is turned off, pulse parameter measurements are stopped and acquisition on that channel is stopped, unless it is needed as an operand for waveform math functions.

Even though the channel display is off, you can still use the plug-in as a trigger source or as a function source in the Math menu. However, the analyzer will not trigger unless one or more of the other channel displays are turned on, or unless a math function is using one of the channels.

Key Path

Channel, *Display*

Scale

Scale

The *Scale* softkey controls the vertical scaling of the waveform. If the fine mode is off, then the knob and arrow keys change the vertical scaling in a 1-2-5 sequence. When fine mode is on, the knob and arrow keys change the vertical scaling in 1 mV increments. You can also use the keypad to enter values in 1 mV increments, independent of the fine mode selection.

The scale will be displayed in volts or watts, as selected by the *Units* softkey. (Amperes, or unknown are available on electrical channels only.)

Key PathChannel, *Scale*

Offset

The *Offset* softkey moves the waveform vertically. It is similar to the position control on analog oscilloscopes. The advantage of digital offset is that it is calibrated. The offset voltage for electrical channels is the voltage at the center of the graticule area, and the range of offset is ± 12 times the full resolution channel scale. For optical channels, the offset wattage is the wattage two graticule divisions above the bottom of the screen. This is set because, unlike voltage displays, "negative" power levels do not exist but the zero power level can be viewed clearly when the offset is set to zero watts. You can use the knob, arrow keys, or keypad to change the offset setting. The fine mode also works with offset.

When an Agilent 54700-series active probe is connected to the probe power connector, the offset control adjusts the external scale factor and offset of the hybrid inside the active probe. A probe connected to the auxiliary power connector will function, but the channel scale factor will *not* be adjusted automatically.

The optical channel displays the value in watts and the electrical channel displays the value in volts.

Key PathChannel, *Offset*

Bandwidth/Wavelength....

You can use the *Bandwidth/Wavelength....* softkey to change the bandwidth and wavelength settings.

Bandwidth

This function is available on the electrical channel only.

You can use the *Bandwidth* function to select either the 12.4 GHz or 20 GHz bandwidth.

Key Path

Channel, *Bandwidth/Wavelength....*, *Bandwidth*

Wavelength

This function is available on the optical channel only.

The *Wavelength* function selects the desired wavelength for calibrated measurements. Factory calibrated wavelengths are 1310 nm and 1550 nm. A user-calibrated wavelength is also available and can be calibrated in the range from 1000 nm to 1600 nm. Refer to Chapter 3, “Calibration Overview” for additional information on performing a calibration.

Key Path

Channel, *Bandwidth/Wavelength....*, *Wavelength*

Filter

This *Filter* function enables you to switch in different hardware filters to create a calibrated reference receiver for compliance testing.

Key Path

Channel, *Bandwidth/Wavelength....*, *Filter On Off*

Filter

This *Filter* function selects the specific filter for the type of compliance testing to be performed. Available filters depend on the module option.

Key Path

Channel, *Bandwidth/Wavelength....*, *Filter*, 155 Mb/s or 622 Mb/s (Option 040)

Channel, *Bandwidth/Wavelength....*, *Filter*, 1063 Mb/s or 1250 Mb/s (Option 041)

Channel autoscale

The *Channel autoscale* softkey provides a convenient and fast method for determining the standard vertical scale setting with the highest resolution that will not clip the waveform. Timebase and trigger settings are *not* affected.

This function is useful in manufacturing environments where the timebase and trigger settings remain constant and only the vertical scale needs to be adjusted for signal level variations in multiple devices under test.

Key PathChannel, *Channel autoscale*

External scale...

The *External scale* softkey allows you to set up the analyzer to use external optical-to-electrical converters or attenuators. Scaling is automatically adjusted to account for the external device.

Key PathChannel, *External scale...****Atten units***

The *Atten units* function lets you select how you want the probe attenuation factor represented. The choices are decibel or ratio. The formula for calculating decibels is:

$$20\log\frac{V_{out}}{V_{in}}\text{ or }10\log\frac{P_{out}}{P_{in}}$$

Attenuation

The *Attenuation* function lets you select an attenuation that matches the device connected to the analyzer. When the attenuation is set correctly, the analyzer maintains the current scale factors if possible. All marker values and voltage or wattage measurements will reflect the actual signal at the input to the external device.

The attenuation range is from 0.0001:1 to 1,000,000:1. When you connect a compatible active probe to the probe power connector, adjacent to the channel input, the instrument automatically sets the attenuation. For all other devices, set the probe attenuation with the knob, arrow keys, or keypad.

Note

Refer to Chapter 3, "Calibration Overview" for information on calibrating to the tip of the probe.

Key Path

Channel, *External scale...., Attenuation*

Units

The *Units* function lets you select the unit of measure appended to the channel scale, offset, trigger level, and vertical measurement values. For the optical channel these units are Volts or Watts. For the electrical channel the units are Volts, Amperes, Watts, or unknown. Use Volt for voltage probes, Ampere for current probes, Watt for optical-to-electrical (O/E) converters, and unknown when there is no unit of measure or when the unit of measure is not one of the available choices.

Key Path

Channel, *External scale...., Units*

Ext gain and Ext offset

When you select Ampere, Watt, or unknown on an electrical channel or Voltage on an optical channel, two additional functions become available: External Gain and External Offset. These two additional functions allow you to compensate for the actual characteristics of the probe rather than the ideal characteristics. For example, you might have an amplified lightwave converter with ideal characteristics of 300 V/W with 0 V offset, but actual characteristics of 324 V/W with 1 mV of output offset. In this case you would set the External Gain to 324 V/W and the External Offset to 1 mV.

Key Path

Channel, *External scale...., Units, Volt, Ext gain or Ext offset*

Channel, *External scale...., Units, Watt, Ext gain or Ext offset*

Channel, *External scale...., Units, Unknown, Ext gain or Ext offset*

Calibrate

Calibrate

The *Calibrate* softkey allows you to null any skew between probes or cables, remove the effects of offsets in the internal O/E converter, recalibrate the responsivity of the O/E converter, and check the present calibration status of the analyzer.

Key PathChannel, *Calibrate***Skew**

The *Skew* function changes the horizontal position of a waveform on the display. The *Skew* function has a range of $\approx +100 \mu\text{s}$. You can use skew to compensate for differences in cable or probe lengths. It also allows you to place the triggered edge at the center of the display when you are using a power splitter connected between the channel and trigger inputs. Another use for skew is when you are comparing two waveforms that have a timing difference. If you are interested in comparing the shapes of two waveforms rather than the actual timing difference, you can use *Skew* to overlay one waveform on top of the other waveform.

To skew two channels

Turn both channels on and overlay the signals vertically.

Expand the time base so the rising edges are at about a 45 degree angle.

Adjust the skew on one of the channels so that the rising edges overlap at the 50 percent points.

Key PathChannel, *Calibrate*, *Skew***Cal status**

The *Cal status* function displays a screen similar to [Figure 2-3](#).

Key PathChannel, *Calibrate*, *Cal Status*

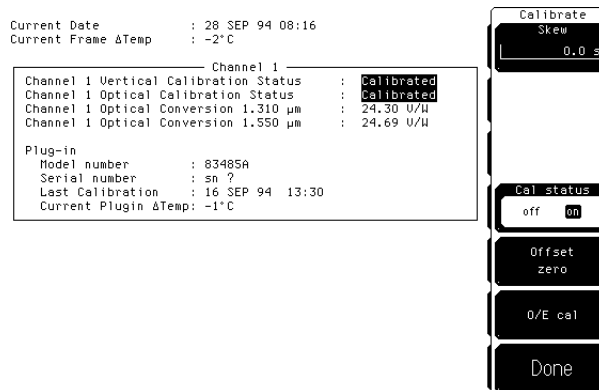

Figure 2-3. A typical Cal Status display.

- Current Date** This is the current date and time. You can compare this to the last plug-in module calibration time to see how long it has been since calibration was performed.
- Current Frame ΔTemp** This is the temperature change on the inside of the instrument since the last mainframe calibration was performed. The number indicates how many degrees warmer or cooler the mainframe is compared to the last calibration.
- Channel 1 Calibration Status** The instrument displays *Calibrated* or *Uncalibrated*, depending on whether the last plug-in module calibration is still valid. A calibration can be invalidated if:
- The mainframe has cycled power.
 - The plug-in has been repaired, reprogrammed, or removed from the mainframe.
 - The instrument's operating temperature has changed and remains more than 5°C from the temperature at which the Plug-in calibration was performed.
- Uncalibrated* indicates the plug-in module vertical calibration is invalid.
- Plug-in** This function lists the model number, serial number, date, time, and temperature delta. The temperature Δ is the mainframe temperature change since the last calibration. If this temperature Δ is greater than $\pm 5^\circ\text{C}$ since the last mainframe calibration, then you must perform a plug-in module calibration to achieve the specified dc accuracy.

Calibrate

Offset zero

The *Offset zero* function performs a quick offset calibration on the optical channel. Since the primary source of calibration error on the optical channel is offset drift, this function is useful:

- after the plug-in module vertical calibration described in Chapter 3, “Calibration Overview” has been performed,

and

- if the plug-in module has not been removed and reinstalled.

Performing an Offset zero calibration is much faster than performing a complete vertical calibration.

Key Path

Channel, *Calibrate*, *Offset zero*

O/E cal

The plug-in module is provided with factory optical calibrations at 1310 nm and 1550 nm. The *O/E cal* function allows you to calibrate the instrument for use at one additional user-defined wavelength between 1000 nm and 1600 nm. This calibration does *not* affect the factory calibrations.

Calibrate probe

Connect a voltage probe to the plug-in and press *Calibrate probe*.

The analyzer calibrates to the tip of the probe by setting the probe attenuation to the actual attenuation ratio of the probe. The analyzer also automatically compensates for any offset the probe may introduce. The CAL signal is internally routed to the probe tip for Agilent Technologies probes.

Key Path

Channel, *Calibrate*, *Calibrate probe*

Calibrate

Factory Calibrations	3-4
User Calibrations—Optical and Electrical	3-7
Complete Calibration Summary	3-19

Calibration Overview

Calibration Overview

This chapter describes the calibration of the mainframe and the plug-in modules. It is intended to give you, or the calibration laboratory personnel, an understanding of the various calibration procedures available, and how they were intended to be used. There is a description of the calibration menu included in the manuals provided with the plug-in modules and probes.

Proper calibration is critical to measurement accuracy and repeatability. The Agilent 54750A/83480A and their associated modules and accessories require that both factory and user calibrations be implemented at the recommended intervals in order to perform measurements at their published specifications.

This chapter is divided into three sections. The first section describes factory calibrations. A factory calibration consists of verifying instrument performance to all specifications. If an instrument fails to meet specifications, adjustment or repair may be necessary. For most users, this will mean shipping the instrument back to an authorized service center. Some users may purchase the required instrumentation and perform the factory timebase calibrations themselves using the optional *Agilent 83480A, 54750A Service Guide*.

The second part of the chapter addresses calibrations that are routinely performed by the end user. Subsections in each of the two main sections discuss the individual calibrations. In addition, there are summary tables at the end of each of these sections summarizing the main areas addressed. The third part of the chapter consists of a complete calibration summary table. Both factory and user calibrations must be performed regularly in order to ensure proper measurement accuracy and repeatability.

CAUTION

The input circuits can be damaged by electrostatic discharge (ESD). Avoid applying static discharges to the front-panel input connectors. Before connecting a coaxial cable to the connectors, momentarily short the center and outer connectors of the cable together. Avoid touching the front panel input connectors without first touching the frame of the instrument. Be sure that the instrument is properly earth-grounded to prevent buildup of static charge. It is strongly recommended that an antistatic mat and wristband be used when connecting to electrical channel inputs.

Calibration interval

Agilent Technologies recommends that the factory calibration be performed on a periodic basis. Agilent Technologies designs instruments to meet specifications over the recommended calibration interval provided that the instrument is operated within the specified operating environment. To maintain specifications, periodic recalibrations are necessary. We recommend that the plug-in module be calibrated at an Agilent Technologies service facility every 12 months. Users are encouraged to adjust the calibration cycle based on their particular operating environment or measurement accuracy needs.

Required warm-up time

The instrument requires a 1 hour warm-up period before any of the calibrations mentioned in this chapter are performed. It is not enough for the instrument to be in the standby setting. It must be turned on and running for the entire hour.

Remote operation

Remote programming commands for calibrations are included in the *Agilent 83480A/Agilent 54750A Programming's Guide*. Performing calibrations remotely is slightly different than the operation of front-panel calibrations.

Factory Calibrations

The following calibrations are performed at the factory:

Mainframe Calibration
O/E Factory Wavelength Calibration

Table 3-1. Factory Calibration Summary

Calibration	What is calibrated	Measurements Affected	Recommended Interval	Softkey Path
Mainframe Calibration	Accuracy and continuity of the timescale	Channels affected: optical & electrical. All time base measurements such as rise time, fall time, eye width, and jitter.	Annually at Agilent service center or if operating temp has changed and remains 5°C or more from calibration temperature. See service manual.	Utility <i>Calibrate</i> <i>Calibrate frame</i>
O/E Factory Wavelength Calibration	The photodetector responsivity	Channels affected: optical. Amplitude accuracy of all optical channel measurements. Optical power meter accuracy.	Annual factory re-calibration of standard wavelengths.	Not user accessible. ^a

a. Refer to "O/E User-Wavelength Calibration" on page 3-9.

Mainframe Calibration

Mainframe calibration affects both optical and electrical measurements. Mainframe calibration improves timebase accuracy. All timebase measurements such as rise time, fall time, eye width, jitter, and so forth are affected by the timebase accuracy.

The calibration factors are stored in the nonvolatile RAM of the instrument. There is a switch on the back panel of the instrument that allows the mainframe calibration to be protected or unprotected. Next to the switch there is a drawing that shows each switch's function and protected position. Refer to the

optional *Agilent 83480A, 54750A Service Guide* for more details about the mainframe calibration, and the position of the rear-panel memory protect switches.

CAUTION

To prevent access to the mainframe calibration switch, place a sticker over the access hole to this switch.

CAUTION

Do not attempt a Mainframe calibration without consulting the *Agilent 83480A, 54750A Service Guide*.

A mainframe calibration should be performed on a periodic basis, annually, or when the ambient operating temperature has changed by and remains 5°C different than the operating temperature at which the last mainframe calibration was performed. To see how much the operating temperature has changed since the last mainframe calibration and the date of the last mainframe calibration, check the Calibration status by pressing the following key sequence:

Utility, *Calibrate*, and then *Cal status on*.

The temperature change is displayed at the top of the display as shown in the following figure.

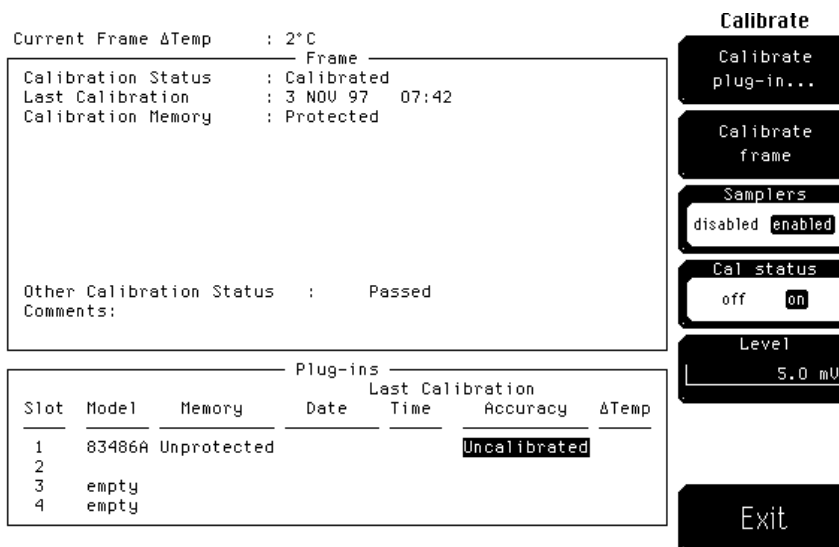

Figure 3-1. Current Frame Δ Temp condition

Factory Calibrations

If the Current Frame Δ Temp listing is greater than $\pm 5^{\circ}\text{C}$, then the mainframe should either be calibrated at the current operating temperature or be placed in an ambient air temperature that is within 5°C of the temperature of the current calibration.

O/E Factory Wavelength Calibration

Optical/electrical (O/E) factory wavelength calibration, compensates for the photodetector responsivity. The accuracy of all optical channel measurements is dependent on proper O/E calibration. O/E calibrations should be performed annually. Most customers return their optical plug-ins to an authorized Agilent Technologies service center for this calibration at the same time they are having their mainframes re-calibrated.

The Agilent 83480-series optical modules have one or two standard wavelengths (850 nm or 1310/1550 nm). The O/E Calibration function allows you to calibrate the instrument for use at one additional user-defined wavelength. This calibration does not affect the factory calibrations. See the following section on User Calibrations for additional information on this procedure.

User Calibrations—Optical and Electrical

The following calibrations can be performed by the user:

- O/E User Wavelength Calibration
- Plug-in Module Vertical Calibration
- Offset Zero Calibration
- Dark Calibration
- Probe Calibration
- Channel Skew
- External Scale

Electrical channels have calibration procedures for:

- adjusting timebase skew, for matching propagation delay between channels, probes, cables, and so forth
- using external probes

Optical channels have calibration procedures for:

- adjusting timebase skew
- monitoring and adjusting internal offsets
- performing a user-defined O/E responsivity adjustment

CAUTION

The input circuits can be damaged by electrostatic discharge (ESD). Avoid applying static discharges to the front panel input connectors. Before connecting a coaxial cable to the connectors, momentarily short the center and outer connectors of the cable together. Avoid touching the front panel input connectors without first touching the frame of the instrument. Be sure the instrument is properly earth-grounded to prevent buildup of static charge. An antistatic mat and wristband are strongly recommended, particularly when working with TDR modules.

User Calibrations—Optical and Electrical**Table 3-2. Optical and Electrical Channel User Calibration Summary**

Calibration	What is calibrated	Measurements Affected	Recommended Interval	Key Path
O/E User Wavelength Calibration	The photodetector responsivity	Channels affected: optical. All optical channel measurements at user wavelengths.	Annual re-calibration of user defined non-factory wavelengths	Optical Channel Setup <i>Calibrate O/E Cal</i>
Plug-in Vertical Calibration	Vertical offset and vertical scale accuracy for both electrical and optical channels.	Channels affected: optical & electrical. Any optical or electrical vertical measurements such as V_p to p , eye height, extinction ratio, and the optical power meter	Perform after any power cycle or once every 10 hours during continuous use or if operating temperature changes by more than 2°C.	Utility <i>Calibrate Calibrate Plug-in</i>
Offset Zero Calibration	Vertical offset is calibrated for the optical channel only. This calibration doesn't include vertical scale accuracy.	Channels affected: optical. Any optical vertical measurements including: V_p to p , eye height, and extinction ratio.	Perform a plug-in vertical calibration in order to meet published specifications. Because the offset zero calibration performs only the offset portion of the plug-in vertical calibration, it should only be used before fast non-critical measurements.	Optical Channel Setup <i>Calibrate Offset 0</i>
Dark Calibration	Dark calibration measures the channel offset signal without any light present and this value is used in the extinction ratio algorithm.	Channels affected: optical & electrical. Extinction ratio.	Before extinction ratio measurements if the vertical scale or offset has changed since the last dark calibration or after a plug-in vertical calibration is performed.	Shift, Meas eye <i>Extinction ratio Dark Cal</i>

Table 3-3. Miscellaneous User Calibration Summary

Calibration	What is calibrated	Measurements Affected	Recommended Interval	Key Path
Probe calibration	Probe Attenuation	Channels affected: electrical. Any electrical measurement taken with the probe	Whenever a probe is connected	Electrical Channel Setup <i>Calibrate</i> <i>Calibrate probe</i>
Channel Skew	Calibrates out the small differences in delay between channels. Useful for looking at timing differences between channels	Channels affected: optical & electrical. Multiple channel measurements.	Before multiple channel measurements when measuring timing differences between channels.	Channel Setup <i>Calibrate</i> <i>Skew</i>
External Scale	Compensates for gain or loss associated with external devices (calibrates vertical scale to external device)	Channels affected: optical & electrical. Any measurement taken through an external device (component or transducer)	Whenever using external devices (component or transducer)	Channel Setup <i>External Scale</i>

O/E User-Wavelength Calibration

This optional optical/electrical (O/E) calibration is for optical measurements only. It compensates for the photodetector's responsivity. The vertical accuracy of all optical channel user wavelength measurements is dependent on proper O/E user wavelength calibration. O/E user-wavelength calibrations should be performed annually or whenever a new wavelength is being measured. To perform a O/E user-wavelength calibration, a CW optical source with a known optical output power level is required. Refer to the specifications for the plug-in module for the acceptable power level ranges.

User Calibrations—Optical and Electrical**NOTE**

The optical channel calibration accuracy is heavily dependent on the accuracy to which you know the optical source power. For best results, measure the optical source power with an optical power meter such as the Agilent 8153A and use precision optical connectors. In addition, proper connector cleaning procedures are essential to obtaining an accurate calibration.

To perform an O/E user-wavelength calibration

- 1 Press the plug-in module's front-panel optical channel SETUP key.
- 2 Press *Calibrate*, and then *O/E cal*.
- 3 Input the correct wavelength, and follow the instructions on the screen.

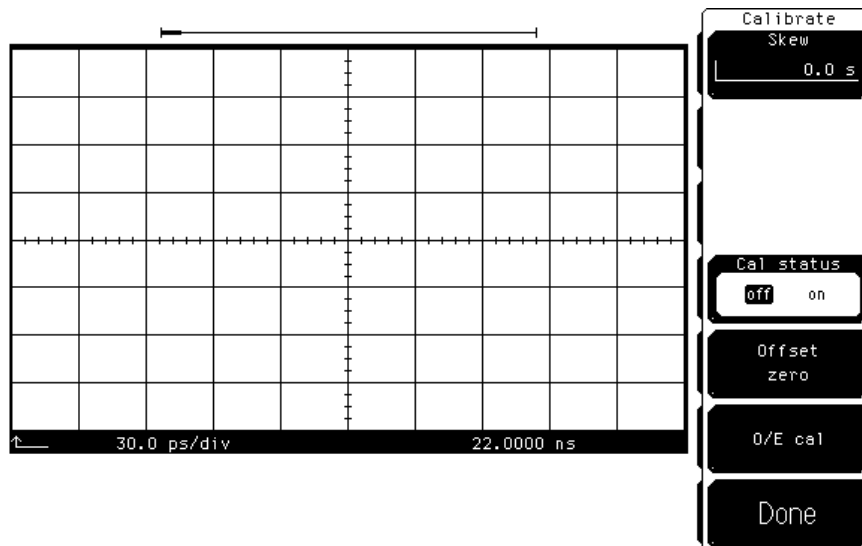
**Figure 3-2. Plug-in calibration menu*****To use an O/E user-wavelength calibration***

- 1 Press the plug-in module's front-panel optical channel SETUP key.
- 2 Press *Bandwidth/wavelength* and then *wavelength*.
- 3 Press *Usr wavelength* and then *Enter*.

Plug-in Module Vertical Calibration

The plug-in module vertical calibration is for both optical and electrical measurements. It allows the instrument to establish the calibration factors for a specific plug-in when the plug-in is installed in the mainframe. The plug-in calibration factors are valid only for the specific mainframe slot in which it was calibrated. The plug-in vertical calibration establishes vertical accuracy.

A plug-in vertical calibration should be done if:

- The mainframe has cycled power.
- The plug-in has been repaired, reprogrammed, or removed from the mainframe.
- The instrument's operating temperature has changed and remains more than 5°C from the temperature at which the Plug-in calibration was performed.

To obtain the best measurement results, it is recommended that a user vertical calibration be performed after every 10 hours of continuous use or if the temperature has changed by greater than 2°C from the previous vertical calibration.

To view the temperature change

This procedure displays the temperature change that the instrument has undergone since the last Plug-in Vertical Calibration.

- 1 Press the front-panel channel SETUP key.
- 2 Press *Calibrate* and then *Cal status on*.

The current plug-in Δ Temp value is listed for each installed module.

To perform a plug-in module vertical calibration

- 1 Remove any front-panel connections from electrical channels.
- 2 Cover the optical inputs for the optical channels.
- 3 Press Utility, *Calibrate...*, and then *Calibrate plug-in...*
- 4 Select the plug-in module to be calibrated, press *1 and 2* or *3 and 4*.
- 5 Press *Start cal* to start the calibration.
- 6 Follow the on-screen instructions.

No additional equipment is required to perform a plug-in vertical calibration. Reference signals are both generated and routed internally, for the optical and electrical channels. If you are prompted to connect the calibrator output to the electrical channel during an optical vertical calibration, then the factory O/E calibration has been lost. The module must then be returned to Agilent Technologies for calibration.

Offset Zero Calibration

The offset zero calibration performs a quick offset calibration on the optical channel for optical measurements. Since the primary source of calibration error on the optical channel is offset drift, this function is useful between the plug-in module vertical calibrations if the plug-in module has not been removed or reinstalled and the operating temperature has not changed more than $\pm 5^{\circ}\text{C}$. In order to ensure that instrument specifications are met, perform the plug-in vertical calibration.

Performing an offset zero calibration is much faster than performing a complete vertical calibration. For critical measurements where offset measurement uncertainty is important to consider, perform an offset zero calibration between module vertical calibrations. Perform an offset zero calibration if the vertical scale or offset changes.

To initiate an offset calibration

- 1** Disconnect all inputs from the module being calibrated.
- 2** Cover all optical inputs.
- 3** Press the plug-in module's front-panel optical channel SETUP key.
- 4** Press *Calibrate* and then *Offset zero*.

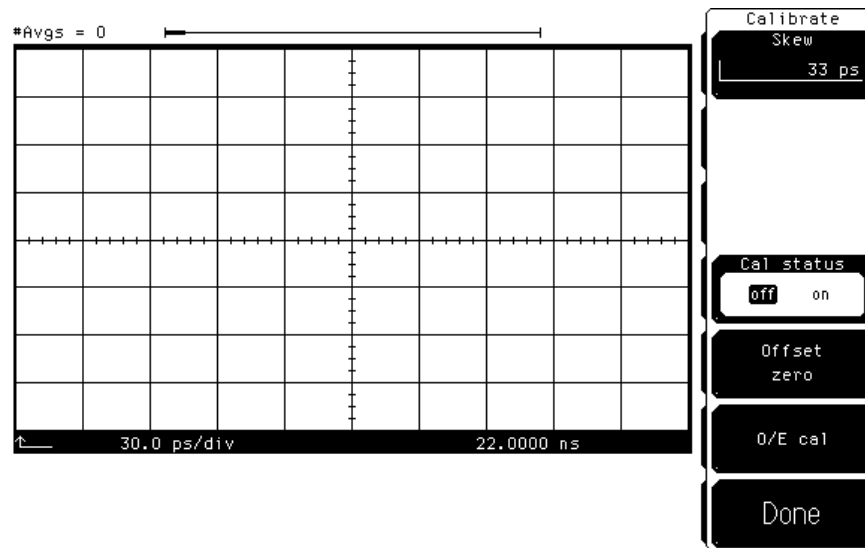

Figure 3-3. Offset Zero Calibration

Dark Calibration

The dark calibration is for optical measurements, or electrical measurements if an external O/E is being used. This calibration measures the optical channel offset signal when there isn't any light present and then uses this information in performing extinction ratio measurements. Dark calibrations should be done for the following conditions:

- Before any critical extinction ratio measurements are made
- After a plug-in vertical calibration
- If a module has been removed
- If the mainframe power has been cycled
- If extinction ratio measurements are being made after the vertical scale or the offset has changed.

If the line power has been cycled, the dark calibration invokes either the offset zero calibration or plug-in vertical calibration as needed. This increases the time required for the dark calibration to complete. The *Dark cal* softkey is located within the Extinction ratio menu.

User Calibrations—Optical and Electrical***To initiate a dark calibration***

- 1 Press the Display key. Press the *Color grade* softkey, and set its setting to *on*.

Color grade must be enabled to perform an extinction ratio measurement and a dark calibration. In addition, the dark level (amplitude when there is no signal present) must be on the screen to perform a dark calibration.

- 2 Press the blue shift key, and then the *Meas eye* softkey which is located beneath the display.

- 3 Press *Extinction ratio...* and then *Dark cal*.

Disconnect all inputs from the module, including the trigger signal, and block any ambient light to the photodetector with a connector plug. Follow the instructions on the screen.

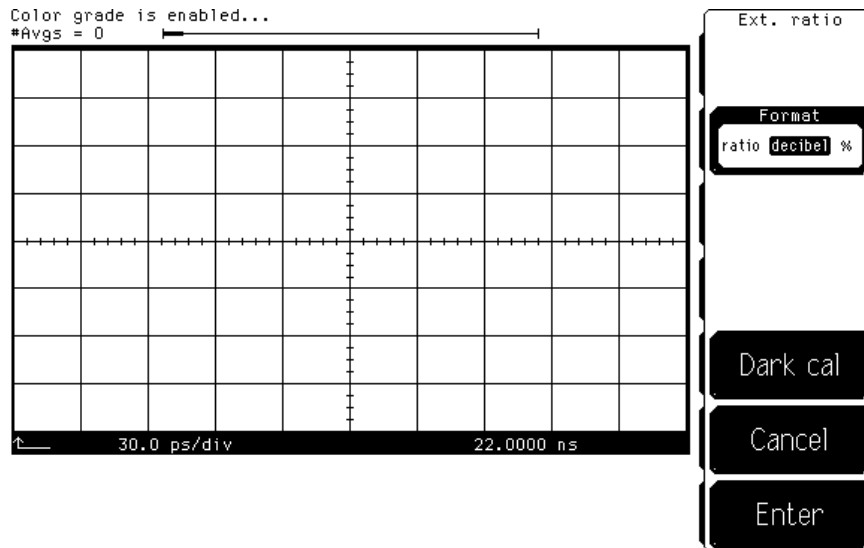

Figure 3-4. Dark calibration menu

Channel Skew Calibration

This calibration affects both optical and electrical measurements. The skew calibration changes the horizontal position of a waveform on the display. The skew calibration has a range of approximately 100 μ s. You can use skew to compensate for the differences in cable or probe lengths. It also allows you to place the trigger edge at the center of the display when you are using a power splitter connected between the channel and trigger inputs. Another use for skew is when you are comparing two waveforms that have a timing difference. If you are interested in comparing the shapes of two waveforms rather than the actual timing difference, you can use skew to overlay one waveform on top of the other waveform.

To skew two channels

- 1 Turn both channels on and overlay the signals vertically.
- 2 Expand the time base so that the rising edges are at about a 45° angle.
- 3 Press the plug-in module's front-panel channel SETUP key.
- 4 Press *Calibrate* and then *Skew*.
- 5 Adjust the skew on one of the channels so that the rising edges overlap at the 50% points.

Probe Calibration

Probe calibration applies to electrical measurements only. For active probes such as the Agilent 54701A, which the instrument can identify through the probe power connector, the instrument automatically adjusts the channel vertical scale factors to the probe's nominal attenuation, even if a probe calibration is not performed.

For passive probes or non-identified probes, the instrument adjusts the vertical scale factors only if a probe calibration is performed. Probe calibration allows the instrument to establish the gain and offset of specific probes that are connected to a channel of the instrument, and then apply those factors to the calibration of that channel.

The analyzer calibrates to the tip of the probe by setting the probe attenuation to the actual attenuation ratio of the probe. The CAL signal is internally routed to the probe tip for Agilent Technologies active probes.

User Calibrations—Optical and Electrical

The mainframe's CAL signal is a voltage source, therefore you can let the instrument compensate for the actual characteristics of your probe by letting the instrument calibrate to the tip of the probe. The instrument automatically calibrates to the tip of the probe, sets the probe attenuation, and compensates for any probe offset.

If you do not perform a probe calibration but want to use a passive probe, enter the attenuation factor using the following steps:

- 1** Press the plug-in module's front-panel channel SETUP key.
- 2** Press *External scale* and then *Attenuation*.

You can use the probe calibration to calibrate any network, including probes or cable assemblies. The instrument calibrates the voltage at the tip of the probe or the cable input.

To calibrate an Agilent Technologies identifiable probe

- 1** Press the plug-in module's front-panel-channel SETUP key.
- 2** Press *Calibrate* and then *Calibrate Probe*.

To calibrate a non-identifiable probe

- 1** Connect the voltage probe to the plug-in.
- 2** Attach the probe tip to the CAL hook that is located near the floppy disk drive.
- 3** Press the plug-in module's front-panel channel SETUP key.
- 4** Press *Calibrate* and then *Calibrate probe*.

If the probe being calibrated has an attenuation factor that allows the instrument to adjust the gain (in hardware) to produce even steps in the vertical scale factors, the instrument will do so. Typically, probes have standard attenuation factors such as divide by 10, divide by 20, or divide by 100.

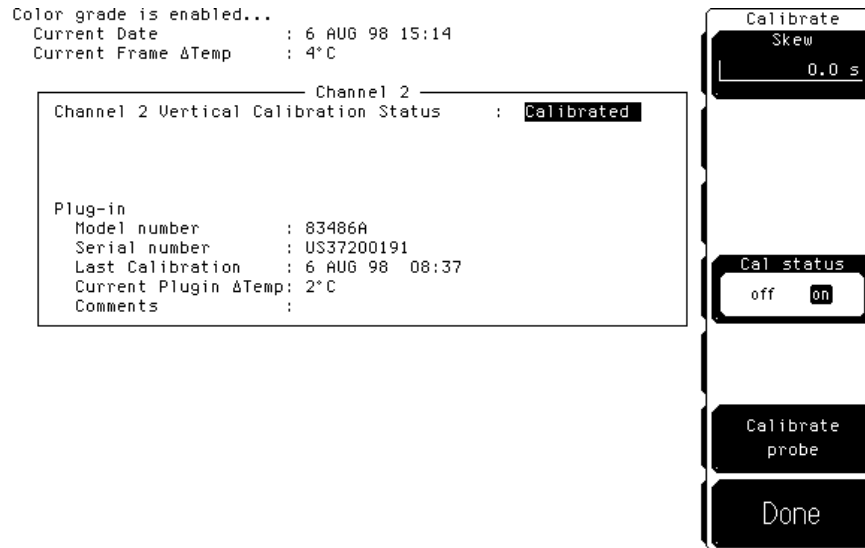

Figure 3-5. Electrical Channel Calibrate Menu

To calibrate other devices

The information in this section applies to both optical and electrical measurements. Since the mainframe's CAL signal is a voltage source, it cannot be used to calibrate to the probe tip when the units are set to Ampere, Watt, or Unknown. Instead, set the external gain and external offset to compensate for the actual characteristics of the probe or device. If you do not know the actual characteristics, you can refer to the typical specifications that came with the probe or device.

- 1 Press the plug-in module's front-panel channel SETUP key.
- 2 Press *External scale*.
- 3 Press *Atten units Ratio, Attenuation 1:1*, and then *Units Ampere* (Volt, Watt, or Unknown).
- 4 Press *Ext gain*, and enter the actual gain characteristics of the probe or device.
- 5 Press *Ext offset*, and enter the offset introduced by the probe or device.

External Scale

Both optical and electrical channels have an External scale setting which allows the user to enter in an offset value to compensate for gains or losses not associated with the device under test. This feature is useful for adjusting out the effects of devices such as test fixtures and attenuators so that the reading on the display gives the measurement value associated with only the actual device under test.

To adjust the external scale

- 1 Press the plug-in module's front-panel channel SETUP key.
- 2 Press *External scale*, and set the *Atten units* to "decibel".
- 3 Press *Attenuation*, and enter the appropriate values.

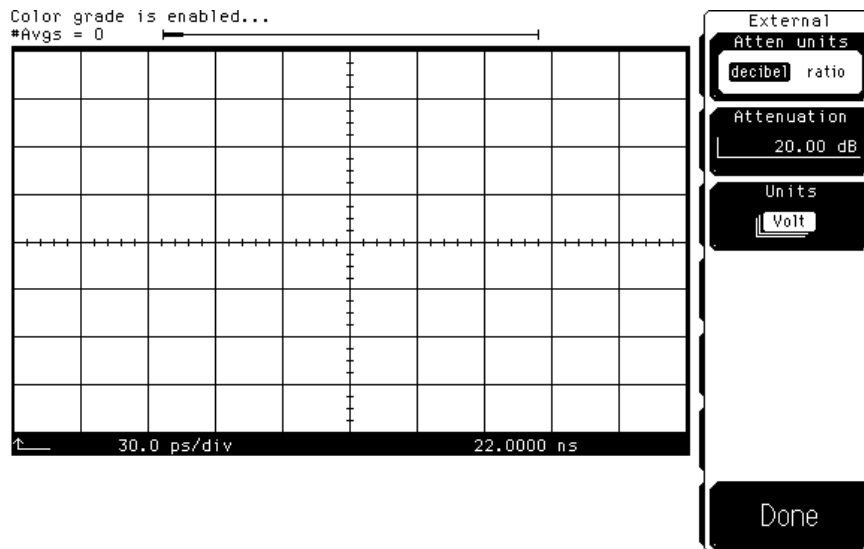

Figure 3-6. External Scale Menu

Complete Calibration Summary

Table 3-4. Complete Calibration Summary (1 of 2)

Calibration	What is calibrated	Measurements Affected	Recommended Interval	Key Path
Mainframe Calibration	Accuracy and continuity of the timescale	Channels affected: optical & electrical. All time base measurements such as rise time, fall time, eye width, and jitter.	Annually at Agilent service center or if operating temp has changed and remains 5°C or more from calibration temperature. See service manual.	Utility <i>Calibrate</i> <i>Calibrate frame</i>
O/E Factory Wavelength Calibration	The photodetector responsivity	Channels affected: optical. Amplitude accuracy of all optical channel measurements. Optical power meter accuracy.	Annual factory re-calibration of standard wavelengths.	Not user accessible. ^a
O/E User Wavelength Calibration	The photodetector responsivity	Channels affected: optical. All optical channel measurements at user wavelengths.	Annual re-calibration of user defined non-factory wavelengths	Optical Channel Setup <i>Calibrate</i> <i>O/E Cal</i>
Plug-in Vertical Calibration	Vertical offset and vertical scale accuracy for both electrical and optical channels.	Channels affected: optical & electrical. Any optical or electrical vertical measurements such as V_p to p, eye height, extinction ratio, and the optical power meter	Perform after any power cycle or once every 10 hours during continuous use or if operating temperature changes by more than 2°C.	Utility <i>Calibrate</i> <i>Calibrate Plug-in</i>

Calibration Overview
Complete Calibration Summary

Table 3-4. Complete Calibration Summary (2 of 2)

Calibration	What is calibrated	Measurements Affected	Recommended Interval	Key Path
Offset Zero Calibration	Vertical offset is calibrated for the optical channel only. This calibration doesn't include vertical scale accuracy.	Channels affected: optical. Any optical vertical measurements including: V_p to p, eye height, and extinction ratio.	Perform a plug-in vertical calibration in order to meet published specifications. Because the offset zero calibration performs only the offset portion of the plug-in vertical calibration, it should only be used before fast non-critical measurements.	Optical Channel Setup <i>Calibrate Offset 0</i>
Dark Calibration	Dark calibration measures the channel offset signal without any light present and this value is used in the extinction ratio algorithm.	Channels affected: optical & electrical. Extinction ratio.	Before extinction ratio measurements if the vertical scale or offset has changed since the last dark calibration or after a plug-in vertical calibration is performed.	Shift, Meas eye <i>Extinction ratio Dark Cal</i>
Probe calibration	Probe Attenuation	Channels affected: electrical. Any electrical measurement taken with the probe	Whenever a probe is connected	Electrical Channel Setup <i>Calibrate Calibrate probe</i>
Channel Skew	Calibrates out the small differences in delay between channels. Useful for looking at timing differences between channels	Channels affected: optical & electrical. Multiple channel measurements.	Before multiple channel measurements when measuring timing differences between channels.	Channel Setup <i>Calibrate Skew</i>
External Scale	Compensates for gain or loss associated with external devices (calibrates vertical scale to external device	Channels affected: optical & electrical. Any measurement taken through an external device (component or transducer)	Whenever using external devices (component or transducer)	Channel Setup <i>External Scale</i>

a. Refer to "O/E User-Wavelength Calibration" on page 3-9.

Specifications 4-3
Characteristics 4-7
Declaration of Conformity 4-8

Specifications and Regulatory Information

Specifications and Regulatory Information

This chapter lists specifications and characteristics of the Agilent 83486A. Specifications apply over the temperature range +15°C to +35°C (unless otherwise noted) after the instrument's temperature has been stabilized after 60 minutes of continuous operation.

Refer to the *Agilent 54701A Active Probe Service Guide* for complete probe specifications.

Specifications *Specifications* described warranted performance.

Characteristics *Characteristics* provide useful, nonwarranted, information about the functions and performance of the instrument. *Characteristics are printed in italics.*

Calibration cycle Agilent Technologies designs instruments to meet specifications over the recommended calibration interval provided that the instrument is operated within the specified operating environment. To maintain specifications, periodic recalibrations are necessary. We recommend that the plug-in module be calibrated at an Agilent Technologies service facility every 24 months. Users are encouraged to adjust the calibration cycle based on their particular operating environment or measurement accuracy needs.

Specifications

Table 4-1. HP 83486A Electrical Channel Vertical Specifications

Bandwidth (–3 dB)	dc to 12.4 GHz or 20 GHz, user selectable
dc Accuracy—single voltage marker ^a	
12.4 GHz	$\pm 0.4\%$ of full scale ± 2 mV $\pm 1.5\%$ (reading – channel offset) $\pm (2\%/^{\circ}\text{C}) (\Delta T_{\text{cal}}^{\text{b}})$ (reading) – 0.4%/hr ($\Delta \text{Time}_{\text{cal}}^{\text{c}}$) (reading)
20 GHz	$\pm 0.4\%$ of full scale ± 2 mV $\pm 3\%$ (reading – channel offset) $\pm (2\%/^{\circ}\text{C}) (\Delta T_{\text{cal}}^{\text{b}})$ (reading) – 0.4%/hr ($\Delta \text{Time}_{\text{cal}}^{\text{c}}$) (reading)
dc Difference—two marker accuracy on same channel ^a	
12.4 GHz	$\pm 0.8\%$ of full scale $\pm 1.5\%$ of delta marker reading $\pm (2\%/^{\circ}\text{C}) (\Delta T_{\text{cal}}^{\text{b}})$ (reading) – 0.4%/hr ($\Delta \text{Time}_{\text{cal}}^{\text{c}}$) (reading)
20 GHz	$\pm 0.8\%$ of full scale $\pm 3\%$ of delta marker reading $\pm (2\%/^{\circ}\text{C}) (\Delta T_{\text{cal}}^{\text{b}})$ (reading) – 0.4%/hr ($\Delta \text{Time}_{\text{cal}}^{\text{c}}$) (reading)
<i>Transition Time (10% to 90%)</i>	
<i>calculated from $T=0.35/BW$, characteristic</i>	
12.4 GHz	≤ 28.2 ps
20 GHz	≤ 17.5 ps
<i>Maximum RMS Noise</i>	
12.4 GHz	≤ 0.5 mV (0.25 mV characteristic)
20 GHz	≤ 1 mV (0.5 mV characteristic)
Scale Factor (full scale is eight divisions)	
Minimum	1 mV/div

Specifications**Table 4-1. HP 83486A Electrical Channel Vertical Specifications (Continued)**

Maximum	100 mV/div
dc Offset Range	±500 mV
Nominal Impedance	50 Ω
Connector	3.5 mm (m)
Reflections	≤5% for 30 ps rise time
Dynamic Range	±400 mV relative to channel offset
<i>Maximum Safe Input Voltage</i>	<i>16 dBm peak ac ±2V dc</i>

- It is recommended that a user vertical calibration be performed after every 10 hours of continuous use or if the temperature has changed by greater than 2°C from the previous vertical calibration.
- Where ΔT_{cal} represents the temperature change in Celsius from the last user vertical calibration. Note that the temperature term goes to zero upon execution of a vertical calibration.
- Where $\Delta \text{Time}_{\text{cal}}$ represents the time since the last user vertical calibration. The uncertainty due to time typically stabilizes after 24 hours. This term goes to zero upon execution of a vertical calibration.

Table 4-2. HP 83486A Optical Channel Vertical Specifications

Bandwidth (–3 dB)	dc to 2.85 GHz (<i>dc to 3.0 GHz characteristic</i>)
Maximum Specified Peak Input Power ^a	
Continuous Wave	0.6 mW (–2.2 dBm)
Modulated	0.4 mW (–4 dBm)
dc Accuracy (single marker ^b) ^c	±0.4% of full scale ±6 μW ±3% (reading – channel offset) ± (2%/°C) (ΔT_{cal} ^d) (reading) – 0.4%/hr ($\Delta \text{Time}_{\text{cal}}$ ^e) (reading)
dc Difference (two marker accuracy, same channel ^b) ^c	±0.8% of full scale ±3% of delta marker reading ± (2%/°C) (ΔT_{cal} ^d) (reading) – 0.4%/hr ($\Delta \text{Time}_{\text{cal}}$ ^e) (reading)
<i>Transition Time (10% to 90%), calculated from $T=0.48/\text{bandwidth}$, optical</i>	<i><160 ps, unfiltered mode</i>
<i>RMS Noise, filtered mode</i>	
Option 040	<i>Characteristic: < 1.0 μW Maximum: < 1.5 μW</i>
Option 041	<i>Characteristic: < 1.5 μW Maximum: < 2.5 μW</i>

Table 4-2. HP 83486A Optical Channel Vertical Specifications (Continued)

Scale Factor (full scale is eight divisions)	
Minimum	5 $\mu\text{W}/\text{div}$
Maximum	100 $\mu\text{W}/\text{div}$
dc Offset Range	+0.2 mW to -0.6 mW, referenced to two divisions above bottom of screen
Connector Type	62.5/125 μm maximum multimode, user selectable connector option
<i>Input Return Loss</i>	
<i>single-mode</i>	<i>33 dB (HMS-10 connector with 9 μm fiber) (characteristic)</i>
<i>multimode</i>	<i>20 dB (HMS-10 connector with fully filled 62.5 μm fiber) (characteristic)</i>
Filtered Bandwidth	
Measured response conforms to:	
Option 040	ITU-TS G.957 and TANWT-000253 for reference receivers for both STM-1/OC-3 and STM-4/OC-12 data rates
Option 041	Reference receiver specifications for FC 1063 and Gigabit Ethernet.
Calibrated Wavelengths	1310 nm and 1550 nm
Average Power Monitor	
Specified operating range	-30 dBm to 0 dBm (1 μW to 1 mW)
Factory calibrated accuracy (20°C to 30°C)	$\pm 5\%$ of reading ± 100 nW \pm connector uncertainty
User calibrated accuracy ^f (<5°C temp change)	$\pm 2\%$ of reading ± 100 nW \pm power meter uncertainty
Maximum Safe Input	10 mW peak
<i>Wavelength Range</i>	<i>1000 to 1600 nm</i>

- a. Exceeding the specified input power level will cause waveform distortion.
- b. Referenced to average power monitor.
- c. It is recommended that a user vertical calibration be performed after every 10 hours of continuous use or if the temperature has changed by greater than 2°C from the previous vertical calibration.
- d. Where ΔT_{cal} represents the temperature change in Celsius from the last user vertical calibration. Note that the temperature term goes to zero upon execution of a vertical calibration.
- e. Where $\Delta \text{Time}_{\text{cal}}$ represents the time since the last user vertical calibration. The uncertainty due to time typically stabilizes after 24 hours. This term goes to zero upon execution of a vertical calibration.
- f. A user calibration can be performed with average optical power levels from 100 to 400 μW , however, the instrument optical accuracy specification is only valid for average optical calibration powers of 200 ± 50 μW .

Specifications

Table 4-3. Electrical and Optical Channels

Temperature	
Operating	15°C to +35°C
Non-operating	-40°C to +70°C
Humidity	
Operating	up to 90% relative humidity (non-condensing) at ≤35°C
Non-operating	up to 95% relative humidity (non-condensing) at ≤65°C

Table 4-4. Power Requirements

Supplied by mainframe.	
------------------------	--

Table 4-5. Weight

Net	approximately 1.2 kg (2.6 lb.)
Shipping	approximately 2.1 kg (4.6 lb.)

Characteristics

The following characteristics are typical for the Agilent 83486A optical/electrical plug-in module. Refer to the *Agilent 54701A Active Probe Service Guide* for complete probe characteristics.

Table 4-6. Trigger Input Characteristics for Electrical and Optical Channels

<i>Nominal Impedance</i>	<i>50 Ω</i>
<i>Input Connector</i>	<i>3.5 mm (m)</i>
<i>Trigger Level Range</i>	<i>± 1 V</i>
<i>Maximum Safe Input Voltage</i>	<i>± 2 Vdc + ac peak (+16 dBm)</i>
<i>Percent Reflection</i>	<i>$\leq 10\%$ for 100 ps rise time</i>

Refer to the *Agilent 83480A, 54750A User's Guide* for trigger specifications.

Declaration of Conformity

Declaration of Conformity

DECLARATION OF CONFORMITY according to ISO/IEC Guide 22 and EN 45014	
Manufacturer's Name:	Hewlett-Packard Co.
Manufacturer's Address:	1400 Fountaingrove Parkway Santa Rosa, CA 95403-1799 USA
declares that the product:	
Product Name:	1300/1500 nm Optical/Electrical Plug-In
Model Number:	HP 83486A
Product Options:	This declaration covers all options of the above product.
conforms to the following Product specifications:	
Safety	IEC 1010-1:1990+A1 /EN 61010-1:1993 CAN/CSA-C22.2 No. 1010.1-92
EMC:	CISPR 11:1990/EN 55011:1991 Group 1, Class A IEC 801-2:1984/EN 50082-1:1992 4 kV CD, 8 kV AD IEC 801-3:1984/EN 50082-1:1992 3V/m, 27-500 MHz IEC 801-4:1984/EN 50082-1:1992 0.5 kV sig. lines, 1 kV power lines IEC 1000-3-2:1995 / EN 61000-3-2:1995 IEC 1000-3-3:1994 / EN 61000-3-3:1995
Supplementary Information: The product herewith complies with the requirements of the Low Voltage Directive 73/23/EEC and the EMC Directive 89/336/EEC and carries the CE-marking accordingly.	
Santa Rosa, CA, USA	27 Feb. 1997
	 John Hlatt/Quality Engineering Manager
European Contact: Your local Hewlett-Packard Sales and Service Office or Hewlett-Packard GmbH, Department HQ-TRE, Herrenberger Strasse 130, D-71034 Böblingen, Germany (Fax +49-7031-14-3143)	

In Case of Difficulty	5-2
Error Messages	5-5
Electrostatic Discharge Information	5-7
Cleaning Connections for Accurate Measurements	5-9
Agilent Technologies Service Offices	5-19

Reference

In Case of Difficulty

This section provides a list of suggestions for you to follow if the plug-in module fails to operate. A list of messages that may be displayed is also included.

Review the procedure being performed when the problem occurred. Before calling Agilent Technologies or returning the unit for service, a few minutes spent performing some simple checks may save waiting for your instrument to be repaired.

This section also includes information regarding electrostatic discharge (ESD), procedures for cleaning both optical and electrical connections, and a list of Agilent Technologies service offices.

If the mainframe does not operate

Make the following checks:

- Is the line fuse good?
- Does the line socket have power?
- Is the unit plugged in to the proper ac power source?
- Is the mainframe turned on?
- Is the rear-panel line switch set to on?
- Will the mainframe power up *without* the plug-in module installed?

If the mainframe still does not power up, refer to the optional *Agilent 83480A, 54750A Service Guide* or return the mainframe to a qualified service department.

If the plug-in does not operate

1 Make the following checks:

- Is the plug-in module firmly seated in the mainframe slot?
- Are the knurled screws at the bottom of the plug-in module finger-tight?
- Is a trigger signal connected to a trigger input?
- If other equipment, cables, and connectors are being used with the plug-in module, are they connected properly and operating correctly?
- Review the procedure for the test being performed when the problem appeared. Are all the settings correct? Can the problem be reproduced?
- Are the connectors clean? See “Cleaning Connections for Accurate Measurements” on page 5-9 for more information.

2 Perform the following procedures:

- Make sure the instrument is ready to acquire data by pressing Run.
- Find any signals on the channel inputs by pressing Autoscale.
- See if any signals are present at the channel inputs by pressing Trigger, *Sweep*, *freerun*.

After viewing the signal, press *triggered*.

- Make sure Channel Display is on by pressing Channel, *Display on off*, on.
- Make sure the channel offset is adjusted so the waveform is not clipped off the display.
- If you are using the plug-in module only as a trigger source, make sure at least one other channel is turned on. If all of the channels are turned off, the mainframe will not trigger.
- Make sure the mainframe identifies the plug-in module by pressing Utility, then *System config...*

The calibration status of the plug-in modules is listed near the bottom of the display, in the box labeled “Plug-ins”. If the model number of the plug-in module is listed next to the appropriate slot number, then the mainframe has identified the plug-in.

If “~known” is displayed instead of the model number of the plug-in module, remove and reinsert the plug-in module in the same slot.

In Case of Difficulty

If “~known” is still displayed, the mainframe may need to have the latest operating system firmware installed. Options 001 and 002 provide this firmware on a 3.5 inch diskette. To load new firmware, follow the instructions provided with this diskette. If you do not have the optional diskette, contact your local Agilent Technologies service office (refer to “Agilent Technologies Service Offices” on page 5-19).

If the mainframe firmware is current and the plug-in module is correctly installed, then the memory contents of the plug-in module are corrupt. Contact a qualified service department.

If all of the above steps check out okay, and the plug-in module still does not operate properly, then the problem is beyond the scope of this book. Return the plug-in module to a qualified service department.

Error Messages

The following error messages are for the plug-in module. Typically, the error messages indicate there is a problem with either the plug-in or the mainframe.

This section explains what the messages mean and offers a few suggestions that might help resolve the error condition. If the suggestions do not eliminate the error message, then additional troubleshooting is required that is beyond the scope of this book. Refer to the *Agilent 83480A, 54750A Service Guide* for additional troubleshooting information.

Additional error messages are listed in the *Agilent 83480A, 54750A User's Guide* for the mainframe.

Memory error occurred in plug-in_:Try reinstalling plug-in

The mainframe could not correctly read the contents of the memory in the plug-in.

- 1 Remove and reinstall the plug-in module. Each time a plug-in is installed, the mainframe re-reads the memory in the plug-in module.
- 2 Verify the plug-in module is firmly seated in the mainframe slot.
- 3 Verify the knurled screws at the bottom of the plug-in module are finger-tight.
- 4 Install the plug-in in a different slot in the mainframe.

Busy timeout occurred with plug-in_:Try reinstalling plug-in

The mainframe is having trouble communicating with the plug-in module. Make sure there is a good connection between the mainframe and the plug-in module.

- 1 Remove and reinstall the plug-in module.
- 2 Verify the plug-in module is firmly seated in the mainframe slot.
- 3 Verify the knurled screws at the bottom of the plug-in module are finger-tight.
- 4 Install the plug-in in a different slot in the mainframe.

Error Messages

Communications failure exists at slot_:Service is required

An illegal hardware state is detected at the mainframe-to-plug-in module interface of the specified slot.

If the slot is empty, there is a mainframe hardware problem. Refer to the *Agilent 83480A, 54750A Service Guide*.

If a plug-in is installed in the slot, there is a plug-in module hardware problem. Return the plug-in module to a qualified service department

ID error occurred in plug-in_:Service is required

The information read from the memory of the plug-in module does not match the hardware in the plug-in module. This can be caused by a communication problem between the mainframe and the plug-in module. Make sure there is a good connection between the mainframe and the plug-in.

- 1 Remove and re-install the plug-in module.
- 2 Verify the plug-in module is firmly seated in the mainframe slot.
- 3 Verify the knurled screws at the bottom of the plug-in module are finger tight.
- 4 The standard Agilent 54750A mainframe does not accept the Agilent 83486A optical/electrical plug-in module. To use the module, a firmware upgrade must first be installed. Order the Agilent 83480K communications firmware kit and install according to the instructions.
- 5 The Agilent 83480A, 54750A mainframes do not accept plug-in modules designed for use with the Agilent 54710A, 54720A.

Plug-in is not supported_:System firmware upgrade is needed

The mainframe may need to have the latest operating system firmware installed. Options 001 and 002 provide this firmware on a 3.5 inch diskette. To load the new firmware, follow the instructions provided with the diskette. If you do not have the optional diskette, contact your local Agilent Technologies service office.

Cal not possible

The power is too low to perform a user O/E calibration.

Electrostatic Discharge Information

Electrostatic discharge (ESD) can damage or destroy electronic components. All work on electronic assemblies should be performed at a static-safe work station. The following figure shows an example of a static-safe work station using two types of ESD protection:

- Conductive table-mat and wrist-strap combination.
- Conductive floor-mat and heel-strap combination.

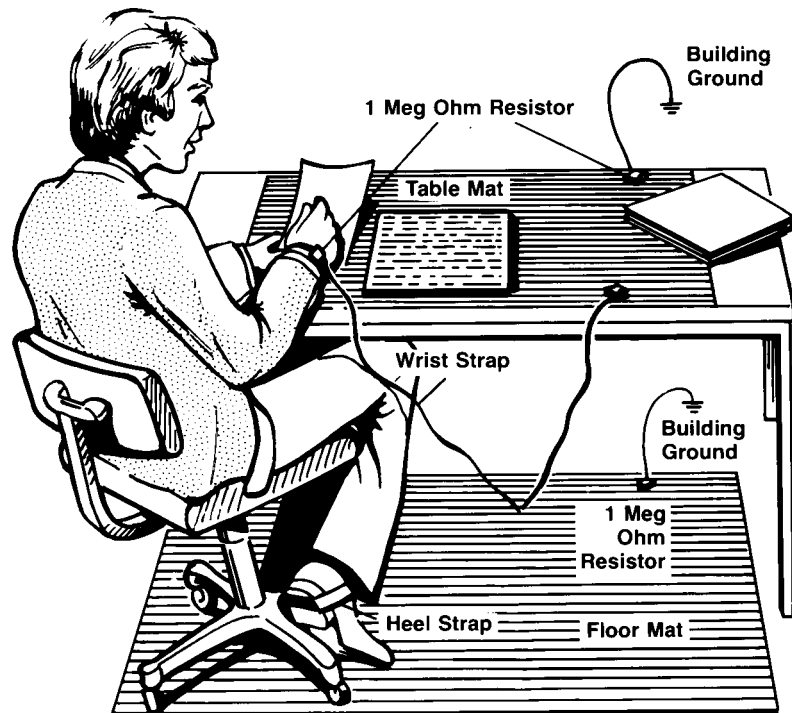

Both types, when used together, provide a significant level of ESD protection. Of the two, only the table-mat and wrist-strap combination provides adequate ESD protection when used alone.

Electrostatic Discharge Information

To ensure user safety, the static-safe accessories must provide at least 1 M Ω of isolation from ground. Refer to [Table 5-1](#) for information on ordering static-safe accessories.

WARNING

These techniques for a static-safe work station should not be used when working on circuitry with a voltage potential greater than 500 volts.

Table 5-1. Static-Safe Accessories

Agilent Part Number	Description
9300-0797	3M static control mat 0.6 m \times 1.2 m (2 ft \times 4 ft) and 4.6 cm (15 ft) ground wire. (The wrist-strap and wrist-strap cord are not included. They must be ordered separately.)
9300-0980	Wrist-strap cord 1.5 m (5 ft).
9300-1383	Wrist-strap, color black, stainless steel, without cord, has four adjustable links and a 7 mm post-type connection.
9300-1169	ESD heel-strap (reusable 6 to 12 months).

Cleaning Connections for Accurate Measurements

Today, advances in measurement capabilities make connectors and connection techniques more important than ever. Damage to the connectors on calibration and verification devices, test ports, cables, and other devices can degrade measurement accuracy and damage instruments. Replacing a damaged connector can cost thousands of dollars, not to mention lost time! This expense can be avoided by observing the simple precautions presented in this book. This book also contains a brief list of tips for caring for electrical connectors.

Choosing the Right Connector

A critical but often overlooked factor in making a good lightwave measurement is the selection of the fiber-optic connector. The differences in connector types are mainly in the mechanical assembly that holds the ferrule in position against another identical ferrule. Connectors also vary in the polish, curve, and concentricity of the core within the cladding. Mating one style of cable to another requires an adapter. Agilent Technologies offers adapters for most instruments to allow testing with many different cables. [Figure 5-1 on page 5-10](#) shows the basic components of a typical connectors.

The system tolerance for reflection and insertion loss must be known when selecting a connector from the wide variety of currently available connectors. Some items to consider when selecting a connector are:

- How much insertion loss can be allowed?
- Will the connector need to make multiple connections? Some connectors are better than others, and some are very poor for making repeated connections.
- What is the reflection tolerance? Can the system take reflection degradation?
- Is an instrument-grade connector with a precision core alignment required?
- Is repeatability tolerance for reflection and loss important? Do your specifica-

Cleaning Connections for Accurate Measurements

tions take repeatability uncertainty into account?

- Will a connector degrade the return loss too much, or will a fusion splice be required? For example, many DFB lasers cannot operate with reflections from connectors. Often as much as 90 dB isolation is needed.

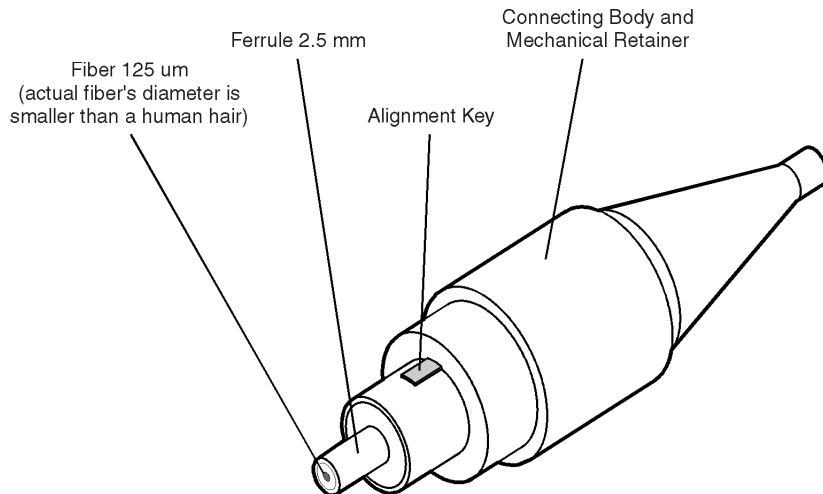

Figure 5-1. Basic components of a connector.

Over the last few years, the FC/PC style connector has emerged as the most popular connector for fiber-optic applications. While not the highest performing connector, it represents a good compromise between performance, reliability, and cost. If properly maintained and cleaned, this connector can withstand many repeated connections.

However, many instrument specifications require tighter tolerances than most connectors, including the FC/PC style, can deliver. These instruments cannot tolerate connectors with the large non-concentricities of the fiber common with ceramic style ferrules. When tighter alignment is required, Agilent Technologies instruments typically use a connector such as the Diamond HMS-10, which has concentric tolerances within a few tenths of a micron. Agilent Technologies then uses a special universal adapter, which allows other cable types to mate with this precision connector. See [Figure 5-2](#).

Cleaning Connections for Accurate Measurements



Figure 5-2. Universal adapters to Diamond HMS-10.

The HMS-10 encases the fiber within a soft nickel silver (Cu/Ni/Zn) center which is surrounded by a tough tungsten carbide casing, as shown in [Figure 5-3](#).

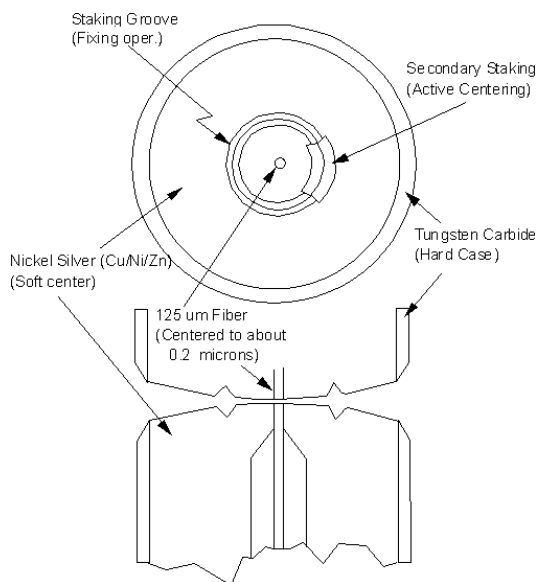

Figure 5-3. Cross-section of the Diamond HMS-10 connector.

The nickel silver allows an active centering process that permits the glass fiber to be moved to the desired position. This process first stakes the soft nickel silver to fix the fiber in a near-center location, then uses a post-active staking to shift the fiber into the desired position within 0.2 μm. This process, plus the keyed axis, allows very precise core-to-core alignments. This connector is found on most Agilent Technologies lightwave instruments.

Cleaning Connections for Accurate Measurements

The soft core, while allowing precise centering, is also the chief liability of the connector. The soft material is easily damaged. Care must be taken to minimize excessive scratching and wear. While minor wear is not a problem if the glass face is not affected, scratches or grit can cause the glass fiber to move out of alignment. Also, if unkeyed connectors are used, the nickel silver can be pushed onto the glass surface. Scratches, fiber movement, or glass contamination will cause loss of signal and increased reflections, resulting in poor return loss.

Inspecting Connectors

Because fiber-optic connectors are susceptible to damage that is not immediately obvious to the naked eye, poor measurements result without the user being aware. Microscopic examination and return loss measurements are the best way to ensure good measurements. Good cleaning practices can help ensure that optimum connector performance is maintained. With glass-to-glass interfaces, any degradation of a ferrule or the end of the fiber, any stray particles, or finger oil can have a significant effect on connector performance. Where many repeat connections are required, use of a connector saver or patch cable is recommended.

Figure 5-4 shows the end of a clean fiber-optic cable. The dark circle in the center of the micrograph is the fiber's 125 μm core and cladding which carries the light. The surrounding area is the soft nickel-silver ferrule. Figure 5-5 shows a dirty fiber end from neglect or perhaps improper cleaning. Material is smeared and ground into the end of the fiber causing light scattering and poor reflection. Not only is the precision polish lost, but this action can grind off the glass face and destroy the connector.

Figure 5-6 shows physical damage to the glass fiber end caused by either repeated connections made without removing loose particles or using improper cleaning tools. When severe, the damage of one connector end can be transferred to another good connector endface that comes in contact with the damaged one. Periodic checks of fiber ends, and replacing connecting cables after many connections is a wise practice.

The cure for these problems is disciplined connector care as described in the following list and in "Cleaning Connectors" on page 5-16.

Cleaning Connections for Accurate Measurements

Use the following guidelines to achieve the best possible performance when making measurements on a fiber-optic system:

- Never use metal or sharp objects to clean a connector and never scrape the connector.
- Avoid matching gel and oils.

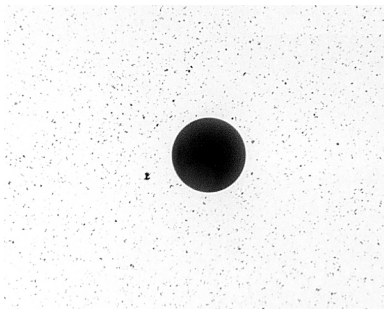

Figure 5-4. Clean, problem-free fiber end and ferrule.

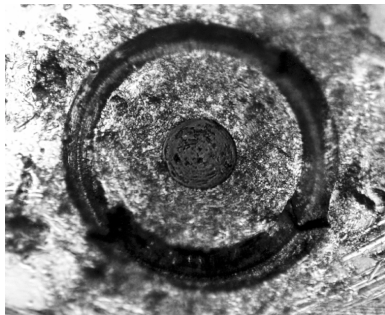

Figure 5-5. Dirty fiber end and ferrule from poor cleaning.

Cleaning Connections for Accurate Measurements**Figure 5-6. Damage from improper cleaning.**

While these often work well on first insertion, they are great dirt magnets. The oil or gel grabs and holds grit that is then ground into the end of the fiber. Also, some early gels were designed for use with the FC, non-contacting connectors, using small glass spheres. When used with contacting connectors, these glass balls can scratch and pit the fiber. If an index matching gel or oil must be used, apply it to a freshly cleaned connector, make the measurement, and then immediately clean it off. Never use a gel for longer-term connections and never use it to improve a damaged connector. The gel can mask the extent of damage and continued use of a damaged fiber can transfer damage to the instrument.

- When inserting a fiber-optic cable into a connector, gently insert it in as straight a line as possible. Tipping and inserting at an angle can scrape material off the inside of the connector or even break the inside sleeve of connectors made with ceramic material.
- When inserting a fiber-optic connector into a connector, make sure that the fiber end does not touch the outside of the mating connector or adapter.
- Avoid over tightening connections.

Unlike common electrical connections, tighter is *not* better. The purpose of the connector is to bring two fiber ends together. Once they touch, tightening only causes a greater force to be applied to the delicate fibers. With connectors that have a convex fiber end, the end can be pushed off-axis resulting in misalignment and excessive return loss. Many measurements are actually improved by backing off the connector pressure. Also, if a piece of grit does happen to get by the cleaning procedure, the tighter connection is more likely to damage the glass. Tighten the connectors just until the two fibers touch.

Cleaning Connections for Accurate Measurements

- Keep connectors covered when not in use.
- Use fusion splices on the more permanent critical nodes. Choose the best connector possible. Replace connecting cables regularly. Frequently measure the return loss of the connector to check for degradation, and clean every connector, every time.

All connectors should be treated like the high-quality lens of a good camera. The weak link in instrument and system reliability is often the inappropriate use and care of the connector. Because current connectors are so easy to use, there tends to be reduced vigilance in connector care and cleaning. It takes only one missed cleaning for a piece of grit to permanently damage the glass and ruin the connector.

Measuring insertion loss and return loss

Consistent measurements with your lightwave equipment are a good indication that you have good connections. Since return loss and insertion loss are key factors in determining optical connector performance they can be used to determine connector degradation. A smooth, polished fiber end should produce a good return-loss measurement. The quality of the polish establishes the difference between the “PC” (physical contact) and the “Super PC” connectors. Most connectors today are physical contact which make glass-to-glass connections, therefore it is critical that the area around the glass core be clean and free of scratches. Although the major area of a connector, excluding the glass, may show scratches and wear, if the glass has maintained its polished smoothness, the connector can still provide a good low level return loss connection.

If you test your cables and accessories for insertion loss and return loss upon receipt, and retain the measured data for comparison, you will be able to tell in the future if any degradation has occurred. Typical values are less than 0.5 dB of loss, and sometimes as little as 0.1 dB of loss with high performance connectors. Return loss is a measure of reflection: the less reflection the better (the larger the return loss, the smaller the reflection). The best physically contacting connectors have return losses better than 50 dB, although 30 to 40 dB is more common.

Cleaning Connections for Accurate Measurements***Visual inspection of fiber ends***

Visual inspection of fiber ends can be helpful. Contamination or imperfections on the cable end face can be detected as well as cracks or chips in the fiber itself. Use a microscope (100X to 200X magnification) to inspect the entire end face for contamination, raised metal, or dents in the metal as well as any other imperfections. Inspect the fiber for cracks and chips. Visible imperfections not touching the fiber core may not affect performance (unless the imperfections keep the fibers from contacting).

WARNING

Always remove both ends of fiber-optic cables from any instrument, system, or device before visually inspecting the fiber ends. Disable all optical sources before disconnecting fiber-optic cables. Failure to do so may result in permanent injury to your eyes.

Cleaning Connectors

The procedures in this section provide the proper steps for cleaning fiber-optic cables and Agilent Technologies universal adapters. The initial cleaning, using the alcohol as a solvent, gently removes any grit and oil. If a caked-on layer of material is still present, (this can happen if the beryllium-copper sides of the ferrule retainer get scraped and deposited on the end of the fiber during insertion of the cable), a second cleaning should be performed. It is not uncommon for a cable or connector to require more than one cleaning.

CAUTION

Agilent Technologies strongly recommends that index matching compounds *not* be applied to their instruments and accessories. Some compounds, such as gels, may be difficult to remove and can contain damaging particulates. If you think the use of such compounds is necessary, refer to the compound manufacturer for information on application and cleaning procedures.

Table 5-2. Cleaning Accessories

Item	Agilent Part Number
Any commercially available denatured alcohol	—
Cotton swabs	8520-0023
Small foam swabs	9300-1223
Compressed dust remover (non-residue)	8500-5262

Table 5-3. Dust Caps Provided with Lightwave Instruments

Item	Agilent Part Number
Laser shutter cap	08145-64521
FC/PC dust cap	08154-44102
Biconic dust cap	08154-44105
DIN dust cap	5040-9364
HMS10/dust cap	5040-9361
ST dust cap	5040-9366

To clean a non-lensed connector**CAUTION**

Do not use any type of foam swab to clean optical fiber ends. Foam swabs can leave filmy deposits on fiber ends that can degrade performance.

- 1** Apply pure isopropyl alcohol to a clean lint-free cotton swab or lens paper.
Cotton swabs can be used as long as no cotton fibers remain on the fiber end after cleaning.
- 2** Clean the ferrules and other parts of the connector while avoiding the end of the fiber.
- 3** Apply isopropyl alcohol to a new clean lint-free cotton swab or lens paper.
- 4** Clean the fiber end with the swab or lens paper.
Do *not* scrub during this initial cleaning because grit can be caught in the swab and become a gouging element.
- 5** Immediately dry the fiber end with a clean, dry, lint-free cotton swab or lens paper.
- 6** Blow across the connector end face from a distance of 6 to 8 inches using filtered, dry, compressed air. Aim the compressed air at a shallow angle to the fiber end face.

Nitrogen gas or compressed dust remover can also be used.

Cleaning Connections for Accurate Measurements

CAUTION

Do not shake, tip, or invert compressed air canisters, because this releases particles in the can into the air. Refer to instructions provided on the compressed air canister.

- 7 As soon as the connector is dry, connect or cover it for later use.

If the performance, after the initial cleaning, seems poor try cleaning the connector again. Often a second cleaning will restore proper performance. The second cleaning should be more arduous with a scrubbing action.

To clean an adapter

The fiber-optic input and output connectors on many Agilent Technologies instruments employ a universal adapter such as those shown in the following picture. These adapters allow you to connect the instrument to different types of fiber-optic cables.



Figure 5-7. Universal adapters.

- 1 Apply isopropyl alcohol to a clean foam swab.

Cotton swabs can be used as long as no cotton fibers remain after cleaning. The foam swabs listed in this section's introduction are small enough to fit into adapters.

Although foam swabs can leave filmy deposits, these deposits are very thin, and the risk of other contamination buildup on the inside of adapters greatly outweighs the risk of contamination by foam swabs.

- 2 Clean the adapter with the foam swab.
- 3 Dry the inside of the adapter with a clean, dry, foam swab.
- 4 Blow through the adapter using filtered, dry, compressed air.

Nitrogen gas or compressed dust remover can also be used. Do not shake, tip, or invert compressed air canisters, because this releases particles in the can into the air. Refer to instructions provided on the compressed air canister.

Agilent Technologies Service Offices

Before returning an instrument for service, call the Agilent Technologies Instrument Support Center at (800) 403-0801, visit the Test and Measurement Web Sites by Country page at <http://www.tm.agilent.com/tmo/country/English/index.html>, or call one of the numbers listed below.

Agilent Technologies Service Numbers

Austria	01/25125-7171
Belgium	32-2-778.37.71
Brazil	(11) 7297-8600
China	86 10 6261 3819
Denmark	45 99 12 88
Finland	358-10-855-2360
France	01.69.82.66.66
Germany	0180/524-6330
India	080-34 35788
Italy	+39 02 9212 2701
Ireland	01 615 8222
Japan	(81)-426-56-7832
Korea	82/2-3770-0419
Mexico	(5) 258-4826
Netherlands	020-547 6463
Norway	22 73 57 59
Russia	+7-095-797-3930
Spain	(34/91) 631 1213
Sweden	08-5064 8700
Switzerland	(01) 735 7200
United Kingdom	01 344 366666
United States and Canada	(800) 403-0801

Index

A

- accessories, 1-7
 - static-safe, 5-8
- active probe, 2-6
- Agilent offices, 5-19
- Atten units softkey, 2-8
- attenuation
 - range, 2-8
- Attenuation softkey, 2-8
- attenuator, scaling, 2-8
- automatic measurement, 2-5
- auxiliary power connector, 1-4

B

- Bandwidth key, 2-7
- Bandwidth/Wavelength... softkey, 2-7

C

- cabinet, cleaning, v
- Cal status softkey, 2-10
- Calibrate probe softkey, 2-12
- Calibrate softkey, 2-10
- calibration
 - external scale, 3-14
 - factory, 3-4
 - mainframe, 3-4
 - O/E, 2-12, 3-6
 - O/E converters, 3-14
 - O/E user wavelength, 3-9
 - offset zero, 2-12, 3-12
 - overview, 3-1
 - plug-in module vertical calibration, 3-11
 - probe, 3-15
 - probes, 3-14
 - skew, 3-14
 - user, 3-7
 - validity, 2-11
 - voltage probe, 3-15
- care
 - of cabinet, v
- care of fiber optics, iv
- channel
 - display, 2-5
 - input, 1-4
 - scale, 2-9
 - setup, 1-2, 2-2

- Channel 1 Calibration Status message, 2-11
- Channel autoscale softkey, 2-8
- Channel key, 1-2, 2-2
- classification
 - product, v
- cleaning
 - adapters, 5-18
 - cabinet, v
 - fiber-optic connections, 5-9, 5-17
 - non-lensed connectors, 5-17
- compressed dust remover, 5-16
- connector
 - care, 5-9
- cotton swabs, 5-16
- Current Date message, 2-11
- Current Frame Delta Temp, 2-11
- customer assistance, vi

D

- damaged shipment, 1-9
- decibel calculation, 2-8
- declaration of conformity, 4-8
- digital offset, 2-6
- Display softkey, 2-5
- dust caps, 5-17

E

- ESD (electrostatic discharge), 5-7
- Ext gain softkey, 2-9
- Ext offset softkey, 2-9
- extender cables, 1-10
- external scale calibration, 3-14
- External scale... softkey, 2-8
- external trigger
 - input, 1-4
 - level, 1-6

F

- factory calibration, 3-4
- fiber optics
 - care of, iv
 - cleaning connections, 5-9
 - connectors, covering, 1-12
- foam swabs, 5-16
- front panel overview, 1-4

Index

fuse, 1-10
values, v

H

horizontal waveform, 2-10

I

IEC Publication 61010-1, v
input
connector, 5-9
INPUT connector, iv
inspecting
instrument, 1-9
instrument
returning for service, 1-11

K

key conventions, 1-8

M

mainframe calibration, 3-4
mainframe troubleshooting, 5-2
marker value, 2-8
math function, 2-5
maximum power input, iv
menu overview, 1-8

O

O/E cal softkey, 2-12
O/E calibration, 3-6
O/E converter calibration, 3-14
O/E user wavelength calibration, 3-9
offset, 2-5-2-6, 2-9, 2-12
Offset softkey, 2-6
offset zero calibration, 3-12
Offset zero softkey, 2-12
optical
channel, 2-7
optical-to-electrical converter scaling, 2-8
options, 1-7

P

packaging for shipment, 1-12
plug-in message, 2-11
plug-in module
features, iii
front panel, 1-4
purpose, iii
serial number, 1-9
plug-in module vertical calibration, 3-11
power
level, 2-6
maximum input, iv
probe
attenuation, 2-8, 2-12
attenuation factor, 2-8
characteristics, 2-9
power, 2-6
power connector, 1-4
probe calibration, 3-14, 3-15
pulse parameter measurements, 2-5

R

regulatory information, 4-2
returning for service, 1-11

S

safety, v
laser classification, v
safety information, iii, vi, 1-10
sales and service offices, 5-19
Scale softkey, 2-6
serial number, 1-9
service, 1-11
returning for, 1-11
sales and service offices, 5-19
shifted function keys, 1-8
shipping
procedure, 1-11
skew calibration, 3-14
Skew softkey, 2-10
softkey
menu, 1-4
overview, 1-8
SONET/SDH filter, 2-7
specifications, 4-2
static-safe accessories, 5-8

swabs, 5-16

T

technical assistance, vi
temperature change, 2-11
trigger
 external, 1-6
 level, 2-9
 source, 2-5

U

Units softkey, 2-6, 2-9
user calibrations, 3-7

V

vertical
 measurement, 2-9
 scale, 2-5-2-8
 waveform, 2-6
voltage
 measurement, 2-8
 probe, 2-12
voltage probe calibration, 3-15

W

wattage measurement, 2-8
waveform
 display, 2-5
 horizontal, 2-10
Wavelength key, 2-7
wavelength settings, 2-7

